

# Buffet Collections

EU 2024



THE ART OF PRESENTATION



THE ART OF PRESENTATION



*a passion to inspire*

Steelite International is the leading designer, marketer, manufacturer, and supplier of award-winning tabletop, buffet and lighting solutions for the global hospitality industry. Dual headquarters, located in New Castle, PA, and Stoke-On-Trent, UK, along with a 500,000 square foot manufacturing facility and fourteen showrooms worldwide, enables us to service over 140 countries for more than 50 years. We are committed to providing the best in functionality and design while minimising the effect on our environment. For more information, please visit [www.steelite.com](http://www.steelite.com).

*the steelite experience*

Customer satisfaction requires dedication, commitment and a passion to achieve levels of excellence far exceeding expectation.

Elevate the buffet experience with Collections Buffet from Steelite International. Alongside our core & partner brands, Steelite has carefully curated an assortment of buffet products which can be found on the subsequent pages.

*We look forward to serving you!*

*showrooms*

Steelite Showrooms provide the perfect opportunity to explore our vast portfolio, and our knowledgeable sales team will offer a solution for any tabletop concept. We are proud to have showrooms in these locations:

- |                       |                           |
|-----------------------|---------------------------|
| UK                    | US                        |
| • London              | • Atlanta, Georgia        |
| • Stoke-on-Trent      | • Chicago, Illinois       |
|                       | • Los Angeles, California |
| EU                    | • Miami, Florida          |
| • Bickenbach, Germany | • New York, New York      |
| • Madrid, Spain       | • Washington, D.C.        |
|                       | • Youngstown, Ohio        |
| ASIA                  | CA                        |
| • Hong Kong           | • Toronto, Ontario        |
| AUS                   |                           |
| • Sydney, NSW         |                           |

*a truly global enterprise*

With a wide range of products, Steelite offers a unique solution for any venue from commercial catering to leisure and hospitality markets, the opportunities are endless with our vast product portfolio.

Steelite core brands include Steelite Distinction & Performance, William Edwards, D.W. Haber, Creations, Folio, Varick, Homer Laughlin, Hall China, Diversified Ceramics, Hollowick, Walco, Aspen Drinkware, and Kenny Mack Designs. In addition to our core brands, we distribute the following prominent brands: Anfora, Bormioli Rocco, Catherine Hurand, Delfin, Fiesta, Genware London, Hepp, Jean Dubost, La Tavola, Maham Studio, MCC, Modern Mixologist, Modern-Twist, Mogogo, MyGlassStudio, Nude, Pasabahce, Pillivuyt, RCP Design, RCR Cristalleria, Rene Ozorio, Robert Gordon Pottery, Robert Welch, Rona 5-Star Glass, Roselli, Royal Porcelain, Strahl, Trudeau, Utopia Tableware, Williamsburg Metalworks, and WNK.





Customer Testimonial

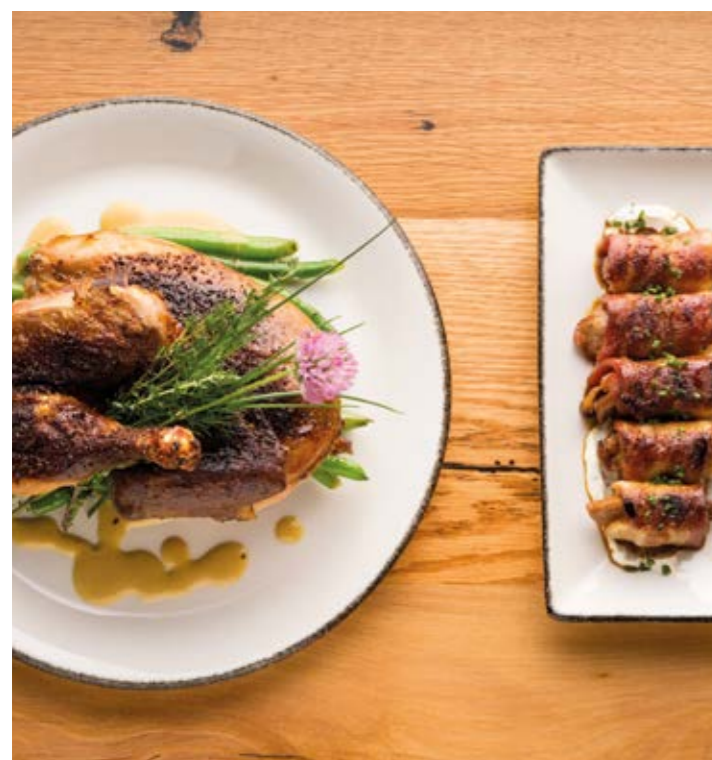

**Brian Landry** Chef/Owner QED Hospitality  
*The Kitchen Table Clermont, KY*

Our restaurant, The Kitchen Table, is located on the Kentucky Bourbon Trail. When opening our restaurant, we wanted pieces that were upscale and comfortable, pieces that would highlight the nature of the bourbon trail. The Steelite products we selected are the perfect balance between high-end quality and comfort.



Customer Testimonial



**Jorge L. Feliz German** President Karisma Dominicana & General Director  
***Karisma Hotels & Resorts Punta Cana***

In collaboration with Steelite, we developed a dinnerware and glassware product guide that is used for all of our restaurant concepts globally. The product catalog complements our Gourmet Inclusive Concept and allows us to provide a unique experience for our guests.

# Table of Contents

<b><i>chafers, marmites &amp; heater stands</i></b>	<b>12</b>	<b><i>heating lamps &amp; carving boards</i></b>	<b>48</b>	<b><i>induction, chafing fuel &amp; burners</i></b>	<b>74</b>	<b><i>platters &amp; bowls</i></b>	<b>136</b>	<b><i>hollowware &amp; accessories</i></b>	<b>158</b>	<b><i>serving utensils &amp; accessories</i></b>	<b>170</b>
<b>ROLLTOP CHAFERS</b>		<b>HEATING LAMPS</b>		<b>INDUCTION RANGES</b>		<b>FOLIO</b>		<b>ROBERT WELCH</b>		<b>D.W. HABER</b>	
D.W. Haber	16	Creations	52	D.W. Haber Power Cell	76	Alpha-Ceram Buffet	138	Drift	160	Serving Utensils	172
<b>HINGED CHAFERS</b>		<b>CARVING BOARDS</b>		D.W. Haber	78	<b>CREATIONS MELAMINE</b>		<b>D.W. HABER</b>		<b>ROBERT WELCH</b>	
D.W. Haber	18	D.W. Haber	54	<b>CHAFING FUEL &amp; BURNERS</b>		Pompeii Buffet	140	Tower	162	Radford	174
Creations	22	<b><i>beverage &amp; cereal dispensers</i></b>	<b>56</b>	Hollowick	80	Gastronorm Trays	142	Traditional & Tear Drop	163	Signature	175
Walco	24	<b>COFFEE URNS &amp; AIRPOTS</b>		<b><i>custom powder coating</i></b>	<b>84</b>	Craft	144	Accessories	164	<b>FOLIO</b>	
<b>MARMITES</b>		D.W. Haber	60	<b><i>visual display</i></b>	<b>88</b>	Quarry	146	<b>KENNY MACK</b>		Bryce	176
D.W. Haber	30	<b>JUICE DISPENSERS</b>		<b>D.W. HABER</b>		Scape	148	Spoon Rests	165	Angle	177
<b>HEATER STANDS</b>		D.W. Haber	62	Fusion Buffet System	106	<b>KENNY MACK RESIN</b>		<b>CREATIONS</b>		<b>WALCO</b>	
D.W. Haber	32	Touchless Taps	64	Fusion Risers & Tiles	114	Cameron	150	Metal Accessories	166	Serving Utensils	178
<b>HOMESTYLE CHAFERS</b>		Creations	65	Fusion Buffet System Overview	116	Wave	152	Royce	168	<b>MODERN-TWIST</b>	
D.W. Haber	34	<b>MILK &amp; CEREAL DISPENSERS</b>		Fusion Inserts & Accessories	124	Jagged Edge & Bark	154	<b>WILLIAMSBURG METALWORKS</b>		Placemats, Runners & Trivets	180
Creations	40	D.W. Haber	66	Presentation Tiered Displays	126	Trays	155	Trays	169	<b><i>care &amp; use</i></b>	<b>182</b>
<b>COOKWARE &amp; BAKEWARE</b>		Creations	67	<b>CREATIONS</b>		Bowls	156				
Folio Cookware	42	<b>CHILLERS, COOLERS &amp; COFFEE POURERS</b>		Wood Buffet Display	128						
Craft Cookware	44	D.W. Haber	68	Display Stands	130						
Simplicity Cookware	45	Creations	70								
<b>FOOD PANS &amp; INSERTS</b>		Robert Welch	71	<b>RISERS</b>							
Hall China	46	<b>ACCESSORIES</b>		Folio Roselli Resin Risers	132						
		Kenny Mack	72	Roselli Porcelain Risers	134						
				<b>KENNY MACK</b>							
				Carved & Smooth Risers	135						





## Chafers, Marmites & Heater Stands

Create a visual impact by separating the ordinary from the extraordinary in buffet. Steelite International shares your passion for excellence in catering through superior offerings in chafers, marmites, and heater stands.

This section highlights all induction-capable and traditional fuel units.



Steelite Performance  
Ink Nomad Blue  
**17620566**  
Coupe Plate  
D 25.25cm (10")

Rona Eclipse  
**480138R002** ●  
Juice Tumbler  
(12¼oz)  
Not available in  
the EMEA

D.W. Haber  
**DW08H40KGBK** ●  
Black Tower Heater Stand w/Grill  
101.6cm x 35.6cm (L 40" W 14")  
  
Hollowick  
**HWEZ638** ●  
Easy Heat 6-3-8 Hour Chafing Fuel

Creations Homestyle Chafer  
**7353MW301** ●  
Round Antique Brushed Bronze  
3.8L (4qts)  
38.1 x 31.8 x 12.7cm H  
(15" x 12½" x 5" H)

Steelite Performance  
Ink Nomad Blue  
**17620569**  
Coupe Bowl  
25.25cm (D 10" H 1½")  
120.25cl (42.3oz)

Varick 18/0  
**5735SX**  
Fulton Vintage Copper

Creations Wood  
**6525T192** ●  
Acacia Bread Board Paddle  
(L 17" W 8")

Steelite Performance  
Aurora Vesuvius  
**17820481**  
Bowl  
13.5cm (D 5¼") 45.5cl (16oz)





*cleverly designed for your buffet presentation*

D.W. Haber's Rolltop Chafers feature the acclaimed patented balance-cover mechanism which prevents the lid from slamming back. These stainless steel vessels have a clever condensation return which returns water back to the water pan. The chafers work well in any buffet occasion, and pair perfectly with the hinged and liftoff-lid marmites. Available in Tempo or Millennium, D.W. Haber chafers pair with a wide variety food pans to accommodate your foodservice needs.

*tempo*



Tempo Rectangular Rolltop Chafers  
**DW78RFWSS** ●  
71.1cm (L 28" W 22" H 15")  
7.5L (8qt) (G/N 1/1)



Tempo Round Rolltop Chafers  
**DW76RFWSS** ●  
53.3cm (L 21" W 21" H 20") 7.5L (2gal)

*millennium*



Millennium Rectangular Rolltop Chafers  
**DW78RFDSC** ●  
67.3cm (L 26½" W 19" H 19½")  
7.5L (8qt) (G/N 1/1)



Millennium Round Rolltop Chafers  
**DW76RFDSC** ●  
55.9cm (L 22" W 22" H 19") 7.5L (2gal)

*food pans*



Food Pan  
**DW06RFP4**  
38.7cm (D 15¼" H 3") 7.5L (2gal)  
For 5.7L/2gal Round



Divided Food Pan  
**DW06RFP2**  
38.7cm (D 15¼" H 3") 7.5L (2gal)  
For 5.7L/2gal Round



Half Round Food Pan  
**DW06RFP22** ●  
38.1cm (L 15" W 6½" H 3")  
7.5L (2gal) For 5.7L/2gal Round  
Spacer Bar  
**DW06RFP22BAR** ●  
For Half Round Food Pan  
37.5cm (L 14¾" W ¾" H ¾")



Rectangular Food Pan  
**DW08RFP**  
54.6cm (L 21½" W 13" H 2¾")  
7.5L (8qt)  
For 2 gal Rectangle Chafers



Porcelain Food Pan  
**DW06RFP4POR**  
38.7cm (D 15¼" H 3") 7.5L (2gal)  
For 5.7L/2gal Round



S Divided Porcelain Food Pan  
**DW06RFP2SPOR** ●  
38.7cm (D 15¼" H 3") 7.5L (2gal)  
For 5.7L/2gal Round



Shallow Round Food Pan  
**DW06RFP3** ●  
38.7cm (D 15¼" H 1")  
For 2 gal Round Chafers

Pair with Hollowick Chafing Fuels. See pages 80-83 for more information.

**HWEZ425** ● Easy Heat 4-2-5 Hour • **HWPLUS4** ● Ready Heat Plus 4 Hour • **HWREADY4** ● Ready Heat 4 Hour • **HWBUFF4** ● Buffet Heat 4 Hour

All chafers include a stainless steel food pan.

D=Diameter L=Length W=Width H=Height • All Products are Measured at Max Capacity (oz)

● Non-Stock

## Backed by D.W. Haber's warranty

- Patented hinge effortlessly stops in any position
- Removable lid for ease of cleaning
- Compatible with induction, heater stands, or chafer frames
- Available with a solid or full glass lid
- Built-in condensation system that returns condensation back into the water pan



### *patented hinge effortlessly stops in any position*

Elevate your buffet service with D.W. Haber's Hinged Chafers. With the capability to work on induction, heater stands, or chafer frames, these chafing dishes feature a clever, patented hinge that will stop the lid in any position, making it the ultimate choice for foodservice. These vessels are available with a solid or full glass lid, and have a unique built-in condensation system that returns condensation back in to the water pan.



Power Cell Cordless Induction Range - Patent-Pending  
 220V EU & UK Plug  
**DWELINPCE2E3** • L 37.1cm x W 33.0cm (L 14<sup>5</sup>/<sub>8</sub>" W 13" H 3")  
 Page 76





D.W. HABER *hinged chafers*



D.W. HABER *hinged chafers*



*induction*



Round Induction Chafer Full Glass Lid  
**DW06WGH7SS** 50.8cm (L 20" W 16" H 6") 7.5L (2gal)  
**DW04WGH7SS** 40.6cm (L 16" W 13" H 6") 3.8L (4qt)



Round Induction Chafer  
**DW06WGHSS** 46.4cm (L 18½" W 15¾" H 6") 7.5L (2 gal)  
**DW04WGHSS** 31.8cm (L 12½" W 15½" H 5¾") 3.8L (4qt)



Round Hammered Induction Chafer  
**DW06WGHMSS** 46.4cm (L 18½" W 15¾" H 6") 7.5L (2gal)



Tempo Rectangular Chafer  
**DW08QWHSS** 61.6cm (L 24¼" W 14¾" H 12") 7.5L (2gal) (G/N 1/1)



Tower Rectangular Chafer  
**DW08QKHSS** 61.6cm (L 24¼" W 14¾" H 12") 7.5L (2gal) (G/N 1/1)



Millennium Rectangular Chafer  
**DW08QDHSS** 61.6cm (L 24¼" W 15" H 12") 7.5L (2gal) (G/N 1/1)

*free-standing*

*free-standing*



Tempo Round Chafer Full Glass Lid  
**DW06WH7SS** 45.7cm (L 18" W 18½" H 12") 7.5L (2gal)  
**DW04WH7SS** 38.1cm (L 15" W 15¼" H 11") 3.8L (4qt)



Tempo Round Chafer  
**DW06WHSS** 45.7cm (L 18" W 18½" H 12") 7.5L (2gal)  
**DW04WHSS** 38.1cm (L 15" W 15¼" H 11") 3.8L (4qt)



Saturn Hammered Round Hinged Chafer  
**DW06UHMSS** 46.4cm (L 18½" W 15¾" H 12½") 7.5L (2gal)



Tower Round Chafer Full Glass Lid  
**DW06KH7SS** 44.5cm (L 17½" W 18" H 12") 7.5L (2gal)  
**DW04KH7SS** 38.1cm (L 15" W 15¼" H 11") 3.8L (4qt)



Tower Round Chafer  
**DW06KHSS** 44.5cm (L 17½" W 18" H 12") 7.5L (2gal)  
**DW04KHSS** 38.1cm (L 15" W 15¼" H 11") 3.8L (4qt)



Saturn Round Hinged Chafer  
**DW06UHSS** 46.4cm (L 18½" W 15¾" H 12½") 7.5L (2gal)



Millennium Round Chafer Full Glass Lid  
**DW06DH7SS** 47.0cm (L 18½" W 16" H 12") 5.7L (2gal)  
**DW04DH7SS** 38.7cm (L 15¼" W 15" H 11") 3.8L (4qt)



Millennium Round Chafer  
**DW06DHSS** 47.0cm (L 18½" W 16" H 12") 5.7L (2gal)  
**DW04DHSS** 38.7cm (L 15¼" W 15" H 11") 3.8L (4qt)

*food pans*



Food Pan  
**DW06RFP4** 38.7cm (D 15¼" H 3") 7.5L (2gal) For 5.7L/2gal Round  
**DW64RFP** 30.2cm (L 11⅞" W 11⅞" H 2¾") 3.8L (4qt) For 3.8L/4qt Round



Divided Food Pan  
**DW06RFP2** 38.7cm (D 15¼" H 3") 7.5L (2gal) For 5.7L/2gal Round  
**DW64RFP2** 30.5cm (L 12" W 12" H 3") 3.8L (4qt) For 3.8L/4qt Round



Half Round Food Pan  
**DW06RFP22** 38.1cm (L 15" W 6½" H 3") 7.5L (2gal) For 5.7L/2gal Round  
Spacer Bar  
**DW06RFP22BAR** 37.5cm (L 14¾" W ¾" H ¾")



Rectangular Food Pan  
**DW08FP** 54.6cm (L 21½" W 13" H 2¾") 7.5L (8qt) For 2 gal Rectangle Chafer



White Porcelain Food Pan  
**DW06RFP4POR** 38.7cm (D 15¼" H 3") 7.5L (2gal) For 5.7L/2gal Round  
**DW64RFP4POR** 30.5cm (D 12" H 2¾") 3.8L (4qt) For 3.8L/4qt Round



White S Divided Porcelain Food Pan  
**DW06RFP2SPOR** 38.7cm (D 15¼" H 3") 7.5L (2gal) For 5.7L/2gal Round



Black Porcelain Round Food Pan  
**DW64RFP4PORBK** 30.5cm (D 12" H 2¾") 3.8L (4qt) For 3.8L/4qt Round



Shallow Round Food Pan  
**DW06RFP3** 38.7cm (D 15¼" H 1") For 2 gal Round Chafer

Pair with Hollowick Chafing Fuels. See pages 80-83 for more information.

**HWZ425** • Easy Heat 4-2-5 Hour • **HWPLUS4** • Ready Heat Plus 4 Hour • **HWREADY4** • Ready Heat 4 Hour • **HWBUFF4** • Buffet Heat 4 Hour

All chafers include a stainless steel food pan.

D=Diameter L=Length W=Width H=Height • All Products are Measured at Max Capacity (oz)

• Non-Stock • Stocked In European Warehouse





Round Chafing Dish And Stand  
**7351MW107** ●  
47.6 x 42.5 x 30.4cm (18¾" x 16¾" x 12")  
9.1L (2gal)  
Round Chafing Dish  
**7351MW102**  
47.6 x 42.5 x 19.0cm H (18¾" x 16¾" x 7½" H)  
9.1L (2gal)  
Round Chafing Dish Stand  
**7351MW103**  
30.4 x 39.3 x 16.5cm H (12" x 15½" x 6½" H)



Rectangular Chafing Dish w/Stand  
**7351MW100**  
57.2 x 43.2 x 29.8cm H (22½" x 17" x 11¾" H)  
7.6L (8qts)



Square Chafing Dish and Stand  
**7351MW106** ●  
32.4cm x 31.1cm (12¾" x 12¼") 5.7L (6qts)  
Square Chafing Dish  
**7351MW104** ●  
38.7 x 43.2 x 17.1cm H (15¼" x 17" x 6¾" H)  
5.7L (6qts)  
Square Chafing Dish Stand  
**7351MW105** ●  
32.4 x 31.1 x 16.5cm H (12¾" x 12¼" x 6½" H)  
Square Chafing Dish Food Pan  
**7351MW108** ●  
32.4 x 35.6 x 6.4cm H (L 12¾" W 14" H 2½")  
5.7L (6qts)

Pair with Hollowick Chafing Fuels. See pages 80-83 for more information.

**HWEZ425** ● Easy Heat 4-2-5 Hour • **HWPLUS4** ● Ready Heat Plus 4 Hour • **HWREADY4** ● Ready Heat 4 Hour • **HWBUFF4** ● Buffet Heat 4 Hour

*food pans*



Food Pan  
**DW06RFP4**  
38.7cm (D 15¼" H 3") 7.5L (2gal)  
For 5.7L/2gal Round



Divided Food Pan  
**DW06RFP2**  
38.7cm (D 15¼" H 3") 7.5L (2gal)  
For 5.7L/2gal Round



Half Round Food Pan  
**DW06RFP22** ●  
38.1cm (L 15" W 6½" H 3")  
7.5L (2gal) For 5.7L/2gal Round  
Spacer Bar  
**DW06RFP22BAR** ●  
For Half Round Food Pan  
37.5cm (L 14¾" W ¾" H ¾")



Rectangular Food Pan  
**DW08FP**  
54.6cm (L 21½" W 13" H 2¾")  
7.5L (8qt)  
For 2 gal Rectangle Chafer



Porcelain Food Pan  
**DW06RFP4POR**  
38.7cm (D 15¼" H 3") 7.5L (2gal)  
For 5.7L/2gal Round



S Divided Porcelain Food Pan  
**DW06RFP2SPOR** ●  
38.7cm (D 15¼" H 3") 7.5L (2gal)  
For 5.7L/2gal Round



Shallow Round Food Pan  
**DW06RFP3** ●  
38.7cm (D 15¼" H 1")  
For 2 gal Round Chafer



Square Food Pan  
**7351MW108** ●  
32.4 x 35.6 x 6.4cm H  
(L 12¾" W 14" H 2½") 5.7L (6qts)  
(For 6 qt Square Chafer)

*chafing dishes at a phenomenal price point*

We are pleased to bring hydraulic closing chafing dishes to the Creations collection. Each chafer has a conveniently large glass view in the lid to increase visibility of the food. This features allows for fewer opens, thus keeping the heat in and the food remains at proper serving temperature. Additionally, the easy-to-remove hydraulic lid closes on its own to ensure that food is kept safe and covered during service. Great for any buffet display, these chafers are induction capable and perfectly priced for even the most value-conscious operators.

All chafers include a stainless steel food pan.

D=Diameter L=Length W=Width H=Height • All Products are Measured at Max Capacity (oz)

● Non-Stock ● Stocked in European Warehouse



*designed to withstand the rigours of constant buffet use*

Available with glass or metal lid

Inside cover drip channel collects condensation back into the water pan and not the food pan

3-layer induction

The outside layer is magnetic stainless, which is most efficient when used with the induction heating process. The middle layer is aluminium which spreads heat out evenly. The inside layer is 18/10 stainless, the best for resisting stains.

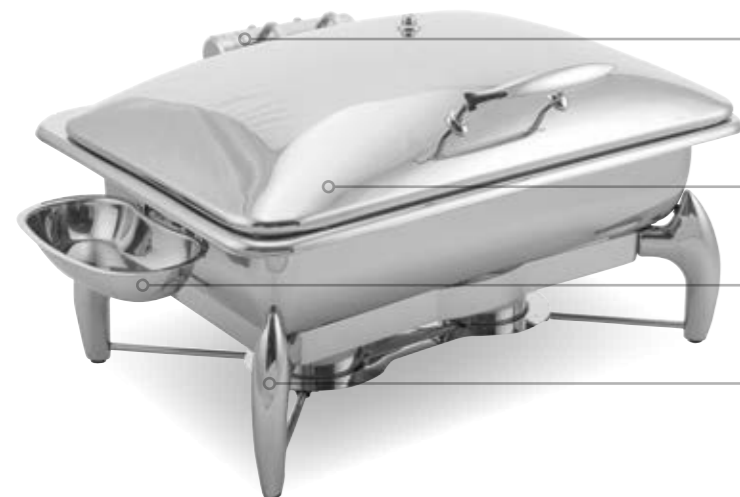

Hinged & self closing lid

Removable lid for easy cleaning

Includes food pan and spoon holder

Separating stand for Hollowick chafing fuel

*heralded as the leading induction ready chafer in the market*

Enhance any buffet presentation with induction ready chafers by Walco. Idol™ chafing dishes are made of high-quality 18/10 stainless steel and are designed to withstand the rigours of foodservice. With the ability to use each chafer on induction or set on a stand to warm with chafing fuel, Walco Idol™ chafers include a built-in holder for a spoon rest to make service simple & convenient. The chafing dishes are also available with a removable, solid stainless lid or glass, to allow customers to effectively see the contents without lifting the lid and releasing heat. Create a visual impact that's sure to impress with Walco chafers.

*induction*



Idol™ Hinged Round Chafer Body w/Metal Lid  
**WLW16UGMT** ●  
L 21" W 18½" H 10¼" (7qt)  
Includes SS food pan and spoon holder



Idol™ Hinged Round Chafer Body w/Glass Top Lid  
**WLW16UGT** ●  
L 21" W 18½" H 10¼" (7qt)  
**WLW14UGT** ●  
L 17¾" W 15½" (4qt)  
Includes SS food pan and spoon holder

*free-standing*



Idol™ Hinged Round Chafer Kit w/Metal Lid  
**WLW16LML** ●  
L 21" W 18½" H 16½" (7qt)  
Includes SS food pan, spoon holder, burner stand and fuel cup



Idol™ Hinged Round Chafer & Stand w/Glass Top Lid  
**WLW16LGL** ●  
L 21" W 18½" (7qt)  
**WLW14LGL** ●  
L 18¾" W 15½" (4qt)  
Includes SS food pan, spoon holder, burner stand and fuel cup

Pair with Hollowick Chafing Fuels. See pages 80-83 for more information. All chafers include a stainless steel food pan.  
**HWEZ638** ● Easy Heat 6-3-8 Hour • **HWPLUS6** ● Ready Heat Plus 6 Hour • **HWREADY6** ● Ready Heat 6 Hour • **HWBUFF624** ● Buffet Heat 6 Hour  
D=Diameter L=Length W=Width H=Height • All Products are Measured at Max Capacity (oz)



*induction*



Idol™ Hinged Rectangle Chafer Body w/Metal Lid  
**WLW19UMT** ●  
L 23¾" W 18½" H 10½" (8qt)  
Includes SS food pan and spoon holder



Idol™ Hinged Rectangle Chafer Body w/Metal Lid  
**WLW155UMT** ●  
L 21" W 12¾" (6qt)  
Includes SS food pan and spoon holder



Idol™ Hinged Rectangle Chafer Body w/Metal Lid  
**WLW135UMT** ●  
L 18½" W 13½" H 10¼" (4qt)  
Includes SS food pan and spoon holder



Idol™ Hinged Rectangle Chafer Body w/Glass Top Lid  
**WLW19UGT** ●  
L 23¾" W 18½" H 10½" (8 qt)  
Includes SS food pan and spoon holder



Idol™ Hinged Rectangle Chafer Body w/Glass Top Lid  
**WLW155UGT** ●  
L 17¼" W 16" H 9" (6 qt)  
Includes SS food pan and spoon holder



Idol™ Hinged Rectangle Chafer Body w/Glass Top Lid  
**WLW135UGT** ●  
L 18½" W 13½" H 10¼" (4 qt)  
Includes SS food pan and spoon holder

*free-standing*



Idol™ Hinged Rectangle Chafer Kit w/Metal Lid  
**WLW19LML** ●  
L 23" W 18½" H 16¾" (8qt)  
Includes SS food pan, spoon holder,  
burner stand and fuel cups



Idol™ Hinged Rectangle Chafer Kit w/Metal Lid  
**WLW155LML** ●  
L 18½" W 17" H 16¼" (6qt)  
Includes SS food pan, spoon holder,  
burner stand and fuel cup



Idol™ Hinged Rectangle Chafer Kit w/Metal Lid  
**WLW135LML** ●  
L 18½" W 13½" H 16¼" (4qt)  
Includes SS food pan, spoon holder,  
burner stand and fuel cup



Idol™ Hinged Rectangle Chafer Kit w/Glass Top Lid  
**WLW19LGL** ●  
L 23" W 11½" H 6¼" (8qt)  
Includes SS food pan, spoon holder,  
burner stand and fuel cups



Idol™ Hinged Rectangle Chafer Kit w/Glass Top Lid  
**WLW155LGL** ●  
L 18¼" W 17" H 16¼" (6qt)  
Includes SS food pan, spoon holder,  
burner stand and fuel cup



Idol™ Hinged Rectangle Chafer Kit w/Glass Lid  
**WLW135LGL** ●  
L 18½" W 13½" H 16½" (4qt)  
Includes SS food pan, spoon holder,  
burner stand and fuel cup



*NSF certified and loaded with great features*

Tested & approved by the NSF organisation, the Walco Idol™ NSF Chafer has an induction ready bottom and a slow closing hinge that ensures the lid will not slam shut during operation. A "dripless" design with ventilation allows condensation on the lid to flow back into the water pan as opposed to on the countertop. With built-in grooves for an NSF-approved serving spoon and tongs, service is convenient, handles won't fall into the food, and the lid closes perfectly to keep the heat in.



Idol™ NSF Chafer  
**WLW155BODY** ●  
L 21" W 12¾" (6qt)  
Food Pan Sold Separately



Idol™ NSF 18/10 Stainless Steel  
Rectangle Food Pan  
**WL8232CT** ●  
L 14" W 12¾" (6qt)



Idol™ NSF Curved  
Handle Serving Spoon  
**WLWL01B** ●  
11⅜"



Idol™ NSF  
Bacon Tongs  
**WL74149B** ●  
L 9"



*induction*



Idol™ Hinged Soup Station Body w/Glass Top Lid  
**WLW11UGT** ●  
L 17" H 15" (11½qt)  
Includes SS food pan and spoon holder



*free-standing*

Idol™ Hinged Round Soup Station Kit w/Glass Top Lid  
**WLW11LSSGL** ●  
L 19¼" W 15" H 19" (11½qt)  
Includes SS food pan, spoon holder, burner stand and fuel cup



Pair with Hollowick Chafing Fuels. See pages 80-83 for more information. All chafers include a stainless steel food pan.  
**HWZ638** ● Easy Heat 6-3-8 Hour • **HWPLUS6** ● Ready Heat Plus 6 Hour • **HWREADY6** ● Ready Heat 6 Hour • **HWBUFF624** ● Buffet Heat 6 Hour

*idol™ chafers storage*

*protect any of your chafers with these hard plastic containers*



Collapsible Storage Box **WLBOXCLG01** ● L 18½" W 27¾" H 20½"



Rectangle Chafers Box **WLBOXLG01** ● L 30"

*4-6 quart options*



Idol™ 18/10 Stainless Steel Round Food Pan  
**WL532508** ●  
D 14" H 3" (4qt)



Idol™ 18/10 Stainless Steel Rectangle Food Pan NSF  
**WL8232CT** ●  
L 14" W 12¼" (6qt)



Idol™ Porcelain Round Food Pan  
**WLW14P** ●  
L 12½" W 12½" (4qt)



Idol™ Porcelain Rectangle Food Pan  
**WLW135P** ●  
L 12¾" W 10½" H 2½" (4qt)



Idol™ Porcelain Rectangle Food Pan  
**WLW155P** ●  
L 21" W 12¾" H 2½" (6qt)

*7-8 quart options*



Idol™ 18/10 Stainless Steel Round Food Pan  
**WLW1608** ●  
D 16¾" (7qt)



Idol™ 18/10 Stainless Steel Divided Food Pan  
**WLW1608D** ●  
D 16¾" (7qt)



Idol™ Porcelain Round Food Pan  
**WL53316** ●  
D 15¾" H 2½" (8qt)



Idol™ Porcelain Round Divided Food Pan  
**WL53316D** ●  
D 15¾" H 2½" (7qt)



Idol™ Porcelain Rectangle Food Pan  
**WLW19P** ●  
L 21" W 12½" H 2½" (8qt)

*12 quart options*



Idol™ 18/10 Stainless Steel Deep Rectangle Food Pan  
**WLW19DSP** ●  
L 21" W 12½" H 3" (12qt)

*soup station options*



Idol™ 18/10 Stainless Steel Soup Bucket  
**WLW11SB** ●  
D 11¼" H 10½" (11½qt)

*food pan gripper*

*the ultimate food pan removing tool*

It protects hands and fingers from burns. It will pry, grip, lift and assist in carrying your food pan from a chafing dish or a steam table. The food pan gripper is also dishwasher safe for easy cleaning.



Food Pan Gripper 18/10 Stainless Steel  
**WLPANGRIP** ●  
L 7¾" W 2" H 4"



*tempo*



Tempo Hinged Marmite  
**DW06SWHSS** ●  
31.1cm  
(L 12¼" W 11¼" H 19½")  
5.7L (6qt)  
Tempo Lifftoff Marmite  
**DW06SWSS** ●  
31.1cm  
(L 12¼" W 11¼" H 19½")  
5.7L (6qt)



Tempo Hinged Marmite  
**DW04SWHSS** ●  
25.4cm (L 10" W 8¾" H 19")  
3.8L (4qt)  
Tempo Hinged Marmite  
**DW02SWHSS** ●  
1.9L (2qt)



Tempo Lifftoff Chafer  
**DW01QWSS** ●  
23.5cm (L 9¼" W 9¼" H 9")  
0.95L (1qt)

*tower*



Tower Hinged Marmite  
**DW06SKHSS** ●  
27.3cm  
(L 10¾" W 11¼" H 19")  
5.7L (6qt)  
Tower Lifftoff Marmite  
**DW06SKSS** ●  
27.3cm  
(L 10¾" W 11¼" H 19")  
5.7L (6qt)



Tower Hinged Marmite  
**DW04SKHSS** ●  
23.5cm (L 9¼" W 8¾" H 18")  
3.8L (4qt)  
Tower Hinged Marmite  
**DW02SKHSS** ●  
1.9L (2qt)



Tower Lifftoff Chafer  
**DW01QHSS** ●  
23.5cm (L 9¼" W 9¼" H 9")  
0.95L (1qt)

*millennium*



Millennium Hinged Marmite  
**DW06SDHSS** ●  
29.8cm  
(L 11¼" W 10¼" H 19½")  
5.7L (6qt)  
Millennium Lifftoff Marmite  
**DW06SDSS** ●  
29.8cm  
(L 11¼" W 10¼" H 19½")  
5.7L (6qt)



Millennium Hinged Marmite  
**DW04SDHSS** ●  
25.4cm (L 10" W 8¾" H 19")  
3.8L (4qt)  
Millennium Hinged Marmite  
**DW02SDHSS** ●  
(L 18" W 10") 1.9L (2qt)



Millennium Lifftoff Chafer  
**DW01QDSS** ●  
23.5cm (L 9¼" W 9¼" H 9½")  
0.95L (1qt)

*marmite inserts*



Insert Pan Petite Marmite w/  
Socket SS  
**DW06SINSHSS** ●  
25.4cm (L 10" W 9½" H 8½")  
5.7L (6qt)



Insert Pan Petite Marmite SS  
**DW06SINSSS** ●  
24.1cm (L 9½" W 9½" H 8½")  
5.7L (6qt)



Insert Pan Marmite Hinged SS  
**DW04SINSHSS** ●  
(L 7½" W 7¼" H 8¼")  
3.8L (4qt)



Insert Pan Marmite Hinged SS  
**DW02SINSHSS** ●  
(D 6" H 7½")  
1.9L (2qt)



Round Food Pan  
**DW01QFP** ●  
(For 1qt Lifftoff Chafer)  
.95L

*durable with efficient heating performance*

D.W. Haber Marmites are the perfect choice for chefs and foodservice professionals who demand high-quality buffetware. These marmites are designed as a double boiler to provide efficient and reliable heating performance without burning, while also being durable and easy to clean. With their heavy-duty, welded stainless steel construction, D.W. Haber Marmites are built to withstand the rigours of commercial kitchen environments. The vessels also feature a sleek & modern design that is available with a hinged cover option and 3 recognisable leg shapes – round Tempo, square Tower, and classically elegant Millennium. Whether you are simmering soups, stews, or sauces, D.W. Haber Marmites are the ideal choice for buffet service.

Pair with Hollowick Chafing Fuels. See pages 80-83 for more information.  
LIFTOFFS: **HWEZ425** ● Easy Heat 4-2-5 Hour • **HWPLUS4** ● Ready Heat Plus 4 Hour • **HWREADY4** ● Ready Heat 4 Hour • **HWBUFF4** ● Buffet Heat 4 Hour  
MARMITES: **HWEZ638** ● Easy Heat 6-3-8 Hour • **HWPLUS6** ● Ready Heat Plus 6 Hour • **HWREADY6** ● Ready Heat 6 Hour • **HWBUFF624** ● Buffet Heat 6 Hour

All marmites include a stainless steel insert.  
D=Diameter L=Length W=Width H=Height • All Products are Measured at Max Capacity (oz) ● Non-Stock





*custom action stations*

The heater stands by D.W. Haber are the ultimate 'wow' factor for your action stations. Available in 20" and 40" sizes, these stands can be customised with a carving board, grill or aluminium insert, and provide the perfect surface for keeping your food warm.

*tempo*



Tempo Heater Stand w/Grill  
**DW08H40WGSS** ●  
101.6cm x 35.6cm (L 40" W 14")  
Chafers sold separately



Tempo Heater Stand w/Grill  
**DW04H202WGSS** ●  
50.8cm x 35.6cm (L 20" W 14")  
Chafers sold separately

Tempo Heater Stand w/Aluminium  
**DW08H40WSS** ●  
101.6cm x 35.6cm (L 40" W 14")

Tempo Heater Stand w/Aluminium  
**DW04H202WSS** ●  
50.8cm x 35.6cm (L 20" W 14")



Maple Carving Board  
**DW04H202CB34** ●  
50.8 x 30.5 x 1.9cm H (L 20" W 14" H 3/4")



Heater Stand Grill  
**DW08H40GRILL** ●  
101.6cm x 36.5cm (L 40" W 14")  
**DW04H202GRILL** ●  
50.8cm x 35.6cm (L 20" W 14")



Heater Stand Aluminium Plate w/Groove  
**DW08H40ALUM** ●  
101.6 x 35.6 x 1.0cm H (L 40" W 14" H 3/8")  
**DW04H202ALUM** ●  
50.8 x 36.5cm (L 20" W 14")



Tower Heater Stand w/Grill  
**DW08H40KGSS** ●  
101.6cm x 35.6cm (L 40" W 14")  
Chafers sold separately



Tower Heater Stand w/Grill  
**DW04H202KGSS** ●  
50.8cm x 35.6cm (L 20" W 14")  
Chafers sold separately



Tower Heater Stand w/Aluminium  
**DW08H40KSS** ●  
101.6cm x 35.6cm (L 40" W 14")



Tower Heater Stand w/Aluminium  
**DW04H202KSS** ●  
50.8cm x 35.6cm (L 20" W 14")



Black Tower Heater Stand w/Grill  
**DW08H40KGBK** ●  
101.6cm x 35.6cm (L 40" W 14")



Black Tower Heater Stand w/Grill  
**DW04H202KGBK** ●  
50.8cm x 35.6cm (L 20" W 14")



Black Tower Heater Stand w/Aluminium  
**DW08H40KBK** ●  
101.6cm x 35.6cm (L 40" W 14")



Black Tower Heater Stand w/Aluminium  
**DW04H202KBK** ●  
50.8cm x 35.6cm (L 20" W 14")

*millennium*



Millennium Heater Stand w/Grill  
**DW08H40DGSS** ●  
101.6cm x 35.6cm (L 40" W 14")  
Chafers sold separately



Millennium Heater Stand w/Grill  
**DW04H202DGSS** ●  
50.8cm x 35.6cm (L 20" W 14")  
Chafers sold separately



Millennium Heater Stand w/Aluminium  
**DW08H40DSS** ●  
101.6cm x 35.6cm (L 40" W 14")



Millennium Heater Stand w/Aluminium  
**DW04H202DSS** ●  
50.8cm x 35.6cm (L 20" W 14")

Pair with Hollowick Chafing Fuels. See pages 80-83 for more information.  
**HWEZ638** ● Easy Heat 6-3-8 Hour • **HWXTRM424** ● Xtreme Heat 4 Hour • **HWPLUS6** ● Ready Heat Plus 6 Hour  
D=Diameter L=Length W=Width H=Height • All Products are Measured at Max Capacity (oz)

● Non-Stock





*rustic meets modern*

Introducing the first ever HomeStyle cast iron chafer. With the rustic appeal of cast iron, these vessels feature a food and water pan concept that keeps your food from drying out, and work perfectly with either fuel or induction.



HomeStyle Dutch Oven/ Cast Iron Chafer  
Red w/ Black Knob (w/o food pan)  
**DWG4R** ● 4.7L (5qt)

Red Cast Iron w/ SS Food Pan  
**DWG4RF** ●



HomeStyle Dutch Oven/ Cast Iron Chafer  
Black w/ Black Knob (w/o food pan)  
**DWG4** ● 4.7L (5qt)

Black Cast Iron w/ SS Food Pan  
**DWG4F** ●



Round Food Pan  
**DW64RFP** ●  
30.2cm (L 11<sup>7</sup>/<sub>8</sub>" W 11<sup>7</sup>/<sub>8</sub>" H 2<sup>3</sup>/<sub>4</sub>")  
3.8L (4qt) For 3.8L/4qt Round



Divided Round Food Pan  
**DW64RFP2** ●  
30.5cm (L 12" W 12" H 3")  
For 3.8L/4qt Round



Black Porcelain Round Food Pan  
**DW64RFPORBK** ●  
30.5cm (L 12" W 12" H 2<sup>3</sup>/<sub>4</sub>")  
3.8L (4qt) For 3.8L/4qt Round



White Porcelain Round Food Pan  
**DW64RFPOR** ●  
30.5cm (L 12" W 12" H 2<sup>3</sup>/<sub>4</sub>")  
3.8L (4qt) For 3.8L/4qt Round

*universal cover holder*



Satin Universal Cover Holder  
**DW396CVRHOLD1** ●  
27.7cm x 11.4cm H (L 10<sup>7</sup>/<sub>8</sub>" H 4<sup>1</sup>/<sub>2</sub>")



Satin Adapter Clip to  
attach cover holder to  
Wood Fusion Risers  
**DWFB14CLIPHOLD1** ●



Tabletop



Attaches to fusion  
metal & wood risers



Attaches to 20" & 40"  
heater stands

All chafers include a stainless steel food pan.

D=Diameter L=Length W=Width H=Height • All Products are Measured at Max Capacity (oz)

● Non-Stock ● Stocked In European Warehouse



***proprietary teflon-coated stainless steel***

The lightweight HomeStyle induction chafers are your go-to vessels for fuel or induction heating. Comprised of stainless steel or coated in black, white or red/black Teflon, these chafing dishes include a food pan, and are chip and scratch resistant. More so, the rectangle chafers have a built-in lid holder for convenient buffet service.



*food pans*



Round Black HomeStyle Chafer  
**DW06CWG8BK** ● (L 17¼" W 15" H 6") 7.5L (2gal)  
**DW04CWG8BK** ● (L 14¼" W 12" H 6¾") 3.8L (4qt)  
**DW02CWG8BK** (L 11½" W 9½" H 5¾") 1.9L (2qt)



Round Black HomeStyle Soup Marmite  
**DW05CWG8BK** ● (L 14¼" W 12" H 7") 5.2L (5½qt)



Rectangle Black HomeStyle Chafer  
**DW04QCWG8BK** ● (L 15½" W 11" H 8") 3.8L (4qt)



Oval Black HomeStyle Chafer  
**DW02145CWG8BK** ● (L 17½" W 11⅞" H 6½") 4.7L (5qt)



Food Pan **DW06RFP4**  
 38.7cm (D 15¼" H 3") 7.5L (2gal)  
 For 5.7L/2gal Round  
**DW64RFP** ●  
 30.2cm (L 11⅞" W 11⅞" H 2¾") 3.8L (4qt) For 3.8L/4qt Round



Divided Food Pan **DW06RFP2**  
 38.7cm (D 15¼" H 3") 7.5L (2gal) For 5.7L/2gal Round  
**DW64RFP2** ●  
 30.5cm (L 12" W 12" H 3") 3.8L (4qt) For 3.8L/4qt Round



Half Round Food Pan **DW06RFP22** ●  
 38.1cm (L 15" W 6½" H 3") 7.5L (2gal) For 5.7L/2gal Round  
 Spacer Bar **DW06RFP22BAR** ●  
 For Half Round Food Pan  
 37.5cm (L 14¾" W ¾" H ¾")



Round Food Pan **DW655RFP** ●  
 For 5½qt Round Chafer



Round Red/Black HomeStyle Chafer  
**DW06CWG8RD2** ● (L 17¼" W 15" H 6") 7.5L (2gal)  
**DW04CWG8RD2** ● (L 14¼" W 12" H 6¾") 3.8L (4qt)  
**DW02CWG8RD2** (L 11½" W 9½" H 5¾") 1.9L (2qt)



Round Red/Black HomeStyle Soup Marmite  
**DW05CWG8RD2** ● (L 14¼" W 12" H 7") 5.2L (5½qt)



Rectangle Red/Black HomeStyle Chafer  
**DW04QCWG8RD2** ● (L 15½" W 11" H 8") 3.8L (4qt)



Oval Red/Black HomeStyle Chafer  
**DW02145CWG8RD2** ● (L 17½" W 11⅞" H 6½") 4.7L (5qt)



Oval Food Pan **DW02145NSS** ●  
 (D 14½")  
 For 5 qt Oval Chafer



White Porcelain Food Pan **DW06RFP4POR**  
 38.7cm (D 15¼" H 3") 7.5L (2gal) For 5.7L/2gal Round  
**DW64RFP4POR** ●  
 30.5cm (D 12" H 2¾") 3.8L (4qt) For 3.8L/4qt Round



White S Divided Porcelain Food Pan **DW06RFP2SPOR** ●  
 38.7cm (D 15¼" H 3") 7.5L (2gal) For 5.7L/2gal Round



Black Porcelain Round Food Pan **DW64RFP4PORBK** ●  
 30.5cm (D 12" H 2¾") 3.8L (4qt) For 3.8L/4qt Round



Round White HomeStyle Chafer  
**DW06CWG8WT** ● (L 17¼" W 15" H 6") 7.5L (2gal)  
**DW04CWG8WT** ● (L 14¼" W 12" H 6¾") 3.8L (4qt)  
**DW02CWG8WT** (L 11½" W 9½" H 5¾") 1.9L (2qt)



Round White HomeStyle Soup Marmite  
**DW05CWG8WT** ● (L 14¼" W 12" H 7") 5.2L (5½qt)



Rectangle White HomeStyle Chafer  
**DW04QCWG8WT** ● (L 15½" W 11" H 8") 3.8L (4qt)



Oval HomeStyle Chafer w/ 2 Handles White  
**DW02145CWG8WT** ● (L 17½" W 11⅞" H 6½") 4.7L (5qt)



Round Food Pan **DW62RFP** ●  
 (D 9½" H 3")  
 For 2 qt Chafer



Shallow Round Food Pan **DW06RFP3** ●  
 38.7cm (D 15¼" H 1")  
 For 2 gal Round Chafer



Rectangular Food Pan **DW04FP**  
 For 4 qt Rectangle Chafer



Round Stainless Steel HomeStyle Chafer  
**DW06DG8SS** ● (L 17¼" W 15" H 6") 7.5L (2gal)  
**DW04CWG8SS** ● (L 14¼" W 12" H 6¾") 3.8L (4qt)



Round HomeStyle Soup Marmite SS  
**DW05CWG8SS** ● (L 14¼" W 12" H 7") 5.2L (5½qt)



Rectangle HomeStyle Chafer SS  
**DW04QCWG8SS** ● (L 15½" W 11" H 8") 3.8L (4qt)



Oval HomeStyle Chafer w/ 2 Handles SS  
**DW02145DG8SS** ● (L 17½" W 11⅞" H 6½") 4.7L (5qt)

All chafers include a stainless steel food pan.

D=Diameter L=Length W=Width H=Height • All Products are Measured at Max Capacity (oz)

● Non-Stock ● Stocked In European Warehouse



Chafers Round Brushed Stainless  
**7352MW302** 9.1L (2gal)  
45.7 x 40.0 x 14.0cm H (18" x 15½" x 5½" H)  
**7352MW301** ● 3.8L (4qts)  
38.1 x 31.8 x 12.7cm H (15" x 12½" x 5" H)  
**7352MW300** 1.9L (2qts)  
30.5 x 25.4 x 12.7cm H (12" x 10" x 5" H)



Chafers Rectangular Brushed Stainless  
**7352MW303** 3.8L (4qts)  
41.9 x 27.3 x 16.5cm H (16½" x 10¾" x 6½" H)



Chafers Round Soup Brushed Stainless  
**7352MW304** 5.2L (5½qts)  
38.1 x 31.8 x 13.3cm H (15" x 12½" x 5¼" H)



Chafers Round Antique Brushed Bronze  
**7353MW302** ● 9.1L (2gal)  
45.7 x 40.0 x 14.0cm H (18" x 15½" x 5½" H)  
**7353MW301** ● 3.8L (4qts)  
38.1 x 31.8 x 12.7cm H (15" x 12½" x 5" H)  
**7353MW300** 1.9L (2qts)  
30.5 x 25.4 x 12.7cm H (12" x 10" x 5" H)



Chafers Rectangular Antique Brushed Bronze  
**7353MW303** ● 3.8L (4qts)  
41.9 x 27.3 x 16.5cm H (16½" x 10¾" x 6½" H)



Chafers Round Soup Antique Brushed Bronze  
**7353MW304** ● 5.2L (5½qts)  
38.1 x 31.8 x 13.3cm H (15" x 12½" x 5¼" H)

*food pans*



Food Pan  
**DW06RFP4**  
38.7cm (D 15¼" H 3") 7.5L (2gal)  
For 5.7L/2gal Round  
**DW64RFP** ●  
30.2cm (L 11⅞" W 11⅞" H 2¾")  
3.8L (4qt) For 3.8L/4qt Round



Divided Food Pan  
**DW06RFP2**  
38.7cm (D 15¼" H 3")  
7.5L (2gal) For 5.7L/2gal Round  
**DW64RFP2** ●  
30.5cm (L 12" W 12" H 3")  
3.8L (4qt) For 3.8L/4qt Round



Half Round Food Pan  
**DW06RFP22** ●  
38.1cm (L 15" W 6½" H 3")  
7.5L (2gal) For 5.7L/2gal Round  
Spacer Bar  
**DW06RFP22BAR** ●  
For Half Round Food Pan  
37.5cm (L 14¾" W ¾" H ¾")



Round Food Pan  
**DW655RFP** ●  
For 5½qt Round Chafers



Round Food Pan  
**DW62RFP** ●  
(D 9½" H 3")  
For 2qt Chafers



White Porcelain Food Pan  
**DW06RFP4POR**  
38.7cm (D 15¼" H 3") 7.5L (2gal)  
For 5.7L/2gal Round  
**DW64RFP4POR** ●  
30.5cm (D 12" H 2¾") 3.8L (4qt)  
For 3.8L/4qt Round



White S Divided Porcelain Food Pan  
**DW06RFP2SPOR** ●  
38.7cm (D 15¼" H 3") 7.5L (2gal)  
For 5.7L/2gal Round



Black Porcelain Round Food Pan  
**DW64RFP4PORBK** ●  
30.5cm (D 12" H 2¾")  
3.8L (4qt) For 3.8L/4qt Round



Shallow Round Food Pan  
**DW06RFP3** ●  
38.7cm (D 15¼" H 1")  
For 2gal Round Chafers



Rectangular Food Pan  
**DW04FP**  
For 4qt Rectangle Chafers

All chafers include a stainless steel food pan.

D=Diameter L=Length W=Width H=Height • All Products are Measured at Max Capacity (oz)

● Non-Stock ● Stocked In European Warehouse

*servicing food in style*

Create an inviting & cosy presentation on your buffet with Homestyle Chafers from Creations. Available in brushed stainless steel and antique bronze finishes, these unique vessels look like cookware you'd use at home, but have the functionality of a high-volume chafing dish at a great price point. Safe for the oven, freezer or on induction, the Homestyle Chafers are also dishwasher safe, making cleanup quick and easy.



*pots & casserole dishes with easy maintenance*

Folio Cookware & Bakeware bring a whole new level of cooking to the kitchen. These 4-ply ceramic, non-stick pots and casserole dishes are made of lightweight cast aluminium and feature an unbreakable body with excellent cold and heat retention. With the versatility of being used on electric or gas cooktops and oven or induction, the cookware pots offer a unique solution for your buffet presentation, while the bakeware crocks and casseroles are oven safe, providing the perfect vessel for single serve items or sides. Each shape is specifically designed for stacking, and is even dishwasher safe!

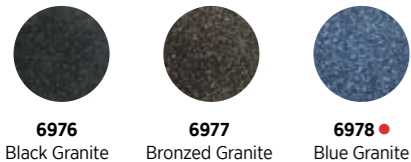

Cooking  
Pots



Round Induction Buffet Pot Black Granite  
w/Tempered Glass Lid  
**6976QU003** 561.9cl (190oz)  
37.5 x 28 x 11.4cm (14<sup>3</sup>/<sub>4</sub>" x 11<sup>3</sup>/<sub>4</sub>" x 4<sup>1</sup>/<sub>2</sub>"")  
**6976QU004** 384.5cl (130oz)  
37.5 x 28 x 8.25cm (14<sup>3</sup>/<sub>4</sub>" x 11<sup>3</sup>/<sub>4</sub>" x 3<sup>1</sup>/<sub>4</sub>"")  
Round Induction Buffet Pot Black Granite (No Lid)  
**6976QU003B** ● L 14<sup>3</sup>/<sub>4</sub>" W 11<sup>3</sup>/<sub>4</sub>" H 4<sup>1</sup>/<sub>2</sub>" (1<sup>1</sup>/<sub>2</sub>gal)  
**6976QU004B** ● L 14<sup>3</sup>/<sub>4</sub>" W 11<sup>3</sup>/<sub>4</sub>" H 3<sup>1</sup>/<sub>4</sub>" (4qt)



Round Induction Buffet Pot Bronzed Granite  
w/Tempered Glass Lid  
**6977QU003** 561.9cl (190oz)  
37.5 x 28 x 11.4cm (14<sup>3</sup>/<sub>4</sub>" x 11<sup>3</sup>/<sub>4</sub>" x 4<sup>1</sup>/<sub>2</sub>"")  
**6977QU004** 384.5cl (130oz)  
37.5 x 28 x 8.25cm (14<sup>3</sup>/<sub>4</sub>" x 11<sup>3</sup>/<sub>4</sub>" x 3<sup>1</sup>/<sub>4</sub>"")  
Round Induction Buffet Pot Bronzed Granite (No Lid)  
**6977QU003B** ● L 14<sup>3</sup>/<sub>4</sub>" W 11<sup>3</sup>/<sub>4</sub>" H 4<sup>1</sup>/<sub>2</sub>" (1<sup>1</sup>/<sub>2</sub>gal)  
**6977QU004B** ● L 14<sup>3</sup>/<sub>4</sub>" W 11<sup>3</sup>/<sub>4</sub>" H 3<sup>1</sup>/<sub>4</sub>" (4qt)



Round Induction Buffet Pot Blue Granite  
w/Tempered Glass Lid  
**6978QU003** 561.9cl (190oz)  
37.5 x 28 x 11.4cm (14<sup>3</sup>/<sub>4</sub>" x 11<sup>3</sup>/<sub>4</sub>" x 4<sup>1</sup>/<sub>2</sub>"")  
**6978QU004** 384.5cl (130oz)  
37.5 x 28 x 8.25cm (14<sup>3</sup>/<sub>4</sub>" x 11<sup>3</sup>/<sub>4</sub>" x 3<sup>1</sup>/<sub>4</sub>"")  
Round Induction Buffet Pot Blue Granite (No Lid)  
**6977QU003B** ● L 14<sup>3</sup>/<sub>4</sub>" W 11<sup>3</sup>/<sub>4</sub>" H 4<sup>1</sup>/<sub>2</sub>" (1<sup>1</sup>/<sub>2</sub>gal)  
**6977QU004B** ● L 14<sup>3</sup>/<sub>4</sub>" W 11<sup>3</sup>/<sub>4</sub>" H 3<sup>1</sup>/<sub>4</sub>" (4qt)

Replacement Tempered Glass Lid W/Silicone Rim and Knob **6975QU002** 27.9cm (11")

*bakeware*



Oval Casserole w/Handles  
**QU012** 85.8cl (29oz)  
26.7 x 18.7 x 4.5cm  
(10<sup>1</sup>/<sub>2</sub>" x 7<sup>3</sup>/<sub>8</sub>" x 1<sup>3</sup>/<sub>4</sub>"")  
**QU011** 165.6cl (56oz)  
32.4 x 22.9 x 5.4cm  
(12<sup>3</sup>/<sub>4</sub>" x 9" x 2<sup>1</sup>/<sub>8</sub>"")



Round Crock  
**QU015** ●  
L 7<sup>1</sup>/<sub>8</sub>" W 5<sup>7</sup>/<sub>8</sub>" H 2<sup>1</sup>/<sub>2</sub>" (22oz)  
Lid For Round Crock  
**QU016** ● D 5<sup>7</sup>/<sub>8</sub>" H 1<sup>1</sup>/<sub>2</sub>"



Oval Mini Crock  
**QU013** 43.6cl (14.75oz)  
17.8 x 12 x 4.5cm  
(7" x 4<sup>3</sup>/<sub>4</sub>" x 1<sup>3</sup>/<sub>4</sub>"")



Round Mini Crock  
**QU009** 32.5cl (11oz)  
14.6 x 11.4 x 4.5cm  
(5<sup>3</sup>/<sub>4</sub>" x 4<sup>1</sup>/<sub>2</sub>" x 1<sup>3</sup>/<sub>4</sub>"")



Round Skillet  
**QU008** 44.4cl (15oz)  
26.7 x 16.5 x 3.5cm  
(10<sup>1</sup>/<sub>2</sub>" x 6<sup>1</sup>/<sub>2</sub>" x 1<sup>1</sup>/<sub>8</sub>"")

D=Diameter L=Length W=Width H=Height • All Products are Measured at Max Capacity (oz)

● Non-Stock



*simmer stew serve*

Inspired by hand-crafted, simple country wares, the Craft Cookware range offers a variety of presentation opportunities to demonstrate the delights of oven to table cooking.

*captivating casual dining*

Bring the intoxicating aromas, sights and sounds of your menu to the guest as you captivate their senses with the Simplicity range of cookware.



Oblong Roaster  
● **11310331** ●  
35.5cm x 30.5cm (14" x 12")  
356cl (125oz)  
● **11330342** ●  
30.5cm x 25.5cm (12" x 10")  
227.0cl (80oz)



Square Roaster  
● **11300329** ●  
25.5cm (10") 185.0cl (65oz)



Oval Sole Dish  
● **11330326** ●  
28.0cm x 19.0cm (11<sup>1</sup>/<sub>8</sub>" x 7<sup>1</sup>/<sub>2</sub>" )  
148.0cl (52oz)



Oval Baker  
● **11300400** ●  
15.75cm (6<sup>1</sup>/<sub>4</sub>" ) 37.0cl (13oz)



Oval Eared Dish  
● **11310321** ●  
34.0cm x 19.0cm (13<sup>1</sup>/<sub>2</sub>" x 7<sup>1</sup>/<sub>2</sub>" )  
103.0cl (36<sup>1</sup>/<sub>2</sub>oz)  
● **11330319** ●  
24.5cm x 13.5cm (9<sup>1</sup>/<sub>2</sub>" x 5<sup>1</sup>/<sub>2</sub>" )  
36.0cl (12<sup>1</sup>/<sub>2</sub>oz)  
● **11300318** ●  
20.0cm x 11.0cm (8" x 4<sup>1</sup>/<sub>2</sub>" )  
18.5cl (6<sup>1</sup>/<sub>2</sub>oz)



Round Eared Dish  
● **11310317** ●  
21.5cm (8<sup>1</sup>/<sub>2</sub>" ) 78.0cl (27<sup>1</sup>/<sub>2</sub>oz)  
● **11300316** ●  
19.0cm (7<sup>1</sup>/<sub>2</sub>" ) 54.0cl (19oz)  
● **11330191** ●  
16.5cm (5<sup>3</sup>/<sub>4</sub>" ) 18.5cl (6<sup>1</sup>/<sub>2</sub>oz)



Presentation Pan  
● **11310866** ●  
25.5cm (10") 96.0cl (33<sup>1</sup>/<sub>2</sub>oz)



Casserole Base  
● **1155B828** ● 42.5cl (15oz)  
Lid for Casserole  
● **11550829** Fits B828

Casserole Base  
● **1131B828** ● 42.5cl (15oz)  
Lid for Casserole  
● **11310829** Fits B828



Oblong Roaster  
● **11010331** ●  
35.5cm x 30.5cm (14" x 12")  
356.0cl (125oz)  
● **11010342** ●  
30.5cm x 25.5cm (12" x 10")  
227.0cl (80oz)



Square Roaster  
● **11010329** ●  
25.5cm (10") 185.0cl (65oz)



Rectangular Tray  
● **11010366** ●  
16.5cm x 12.3cm  
(6<sup>1</sup>/<sub>2</sub>" x 4<sup>3</sup>/<sub>8</sub>" ) 50.0cl (17<sup>1</sup>/<sub>2</sub>oz)



Casserole  
● **11010337** ●  
24.4cm x 11.4cm H (9<sup>5</sup>/<sub>8</sub>" x 4<sup>1</sup>/<sub>2</sub>" H)  
307.6cl (104oz)  
● **11010334** ●  
22.2cm x 10.2cm H (8<sup>3</sup>/<sub>4</sub>" x 4" H)  
221.8cl (75oz)  
Casserole Lid  
● **11010338** 24.4cm (9<sup>5</sup>/<sub>8</sub>" ) Fits 0337  
● **11010335** 22.2cm (8<sup>3</sup>/<sub>4</sub>" ) Fits 0334



Oval Sole Dish  
● **11010326** ●  
28.0cm x 19.0cm (11<sup>1</sup>/<sub>8</sub>" x 7<sup>1</sup>/<sub>2</sub>" )  
148.0cl (52oz)  
● **11010327** ●  
21.5cm x 14.0cm (8<sup>1</sup>/<sub>2</sub>" x 5<sup>1</sup>/<sub>2</sub>" )  
55.0cl (19oz)



Oval Eared Dish  
● **11010321** ●  
34.0cm x 19.0cm (13<sup>1</sup>/<sub>2</sub>" x 7<sup>1</sup>/<sub>2</sub>" )  
103.0cl (36<sup>1</sup>/<sub>2</sub>oz)  
● **11010320** ●  
30.5cm x 17.0cm (12" x 6<sup>1</sup>/<sub>2</sub>" )  
78.0cl (27<sup>1</sup>/<sub>2</sub>oz)  
● **11010319** ●  
24.5cm x 13.5cm (9<sup>1</sup>/<sub>2</sub>" x 5<sup>1</sup>/<sub>2</sub>" )  
36.0cl (12<sup>1</sup>/<sub>2</sub>oz)  
● **11010318** ●  
20.0cm x 11.0cm (8" x 4<sup>1</sup>/<sub>2</sub>" )  
18.5cl (6<sup>1</sup>/<sub>2</sub>oz)



Round Eared Dish  
● **11010317** ●  
21.5cm (8<sup>1</sup>/<sub>2</sub>" ) 78.0cl (27<sup>1</sup>/<sub>2</sub>oz)  
● **11010316** ●  
19.0cm (7<sup>1</sup>/<sub>2</sub>" ) 54.0cl (19oz)  
● **11010191** ●  
16.5cm (6<sup>1</sup>/<sub>2</sub>" ) 18.5cl (6<sup>1</sup>/<sub>2</sub>oz)



Presentation Pan  
● **11010866** ●  
25.5cm (10") 96.0cl (33<sup>1</sup>/<sub>2</sub>oz)



Soup Bowl w/Lid  
● **11010828** ●  
15.9 x 12.4 x 7.6cm H  
(6<sup>1</sup>/<sub>4</sub>" x 4<sup>7</sup>/<sub>8</sub>" x 3" H) 42.5cl (15oz)  
Soup Bowl Base  
● **1101B828** ●  
16.5 x 12.4 x 5.7cm H  
(6<sup>1</sup>/<sub>2</sub>" x 4<sup>7</sup>/<sub>8</sub>" x 2<sup>1</sup>/<sub>4</sub>" H) 42.5cl (15oz)  
● **11010829** Lid



Oval Baker  
● **11010400** ●  
15.75cm (6<sup>1</sup>/<sub>4</sub>" ) 37.0cl (13oz)  
● **11010328** Lipped  
15.75cm (6<sup>1</sup>/<sub>4</sub>" ) 37.0cl (13oz)



*unmatched heat and cold retention*

The ceramic food pans from Hall China allow cooked foods to maintain their quality longer. The ceramic body distributes heat and cold more evenly, all the while elevating the look of any buffet presentation. Available in both bright white and white, these food pans have the ability to match your existing tableware.



HALL CHINA *white*



Full Size Food Pan  
**HL1017POAWHA** ●  
L 20<sup>3</sup>/<sub>4</sub>" W 12<sup>3</sup>/<sub>4</sub>" H 2<sup>1</sup>/<sub>2</sub>"  
(6<sup>1</sup>/<sub>4</sub>qt)



Half Size Food Pan  
**HL1016POAWHA** ●  
L 12<sup>3</sup>/<sub>4</sub>" W 10<sup>3</sup>/<sub>8</sub>" H 2<sup>1</sup>/<sub>2</sub>"  
(2<sup>3</sup>/<sub>4</sub>qt)



Steam Table Inset  
**HL8W0AWHA** ●  
D 10<sup>3</sup>/<sub>4</sub>" H 9" (9qt)  
Fits: 10<sup>1</sup>/<sub>2</sub>" Opening

HALL CHINA *bright white*



Full Size Food Pan  
**HL1017POABWA** ●  
L 20<sup>3</sup>/<sub>4</sub>" W 12<sup>3</sup>/<sub>4</sub>" H 2<sup>1</sup>/<sub>2</sub>"  
(6<sup>1</sup>/<sub>4</sub>qt)



Half Long Food Pan  
**HL1015POABWA** ●  
L 20<sup>3</sup>/<sub>4</sub>" W 6<sup>3</sup>/<sub>8</sub>" H 2<sup>1</sup>/<sub>2</sub>"  
(2<sup>1</sup>/<sub>4</sub>qt)



Half Size Food Pan  
**HL1016POABWA** ●  
L 12<sup>3</sup>/<sub>4</sub>" W 10<sup>3</sup>/<sub>8</sub>" H 2<sup>1</sup>/<sub>2</sub>"  
(2<sup>3</sup>/<sub>4</sub>qt)



Chafing Dish  
**HL8710ABWA** ●  
L 15<sup>1</sup>/<sub>8</sub>" H 2<sup>3</sup>/<sub>4</sub>"  
(5<sup>1</sup>/<sub>4</sub>qt)





## Heating Lamps & Carving Boards

Ideal for maintaining safe temperatures while chefs prepare and serve food on a buffet, D.W. Haber's collection of heat lamps & carving units will create a standout presentation. With telescoping lamps and elevated boards, your catering expectations will be far exceeded through features such as multiple heat lamp finishes, removable & interchangeable carving surfaces, and recessed edges to keep your surfaces clean.



D.W. Haber  
Black Tower  
Heater Stand Frame  
**DW08H40KFRMBK** ●  
101.6cm x 35.6cm  
(L 40" W 14")

Hollowick  
Chafing Fuel  
**HWEZ638** ●  
Easy Heat 6-3-8 Hour

D.W. Haber  
Maple Carving  
Board  
**DW04H202CB34** ●  
50.8cm (L 20" W 14" H 3/4")

D.W. Haber  
Heater Stand Aluminium  
Plate w/Groove  
**DW04H202ALUM** ●  
50.8cm (L 20" W 14")

D.W. Haber  
Grey Wash Square Riser  
**DWFB147WDGW** ●  
35.6cm x 17.8cm (L W 14" H 7")

D.W. Haber  
Round Black HomeStyle Chafer  
**DW06CWG8BK** ●  
38.0cm x 9.0cm H (L 14" W 3 1/2" H 6")  
7.5L (2gal)

D.W. Haber  
Induction Warmer 300 Watt  
**DWELIN300BE2** ● EU Plug  
**DWELIN300BE3** UK Plug  
34.3cm (L 13 1/2" W 12 1/2" H 4 1/2")  
Black Fusion Induction Adapter Ring  
**DWFB14ADAPBK** ●

D.W. Haber  
Grey Wash Square Riser  
**DWFB612WDGW** ●  
15.2cm x 30.5cm  
(L W 6" H 12")

D.W. Haber  
Black Glass Square Tile  
**DWFBGL6BK** ●  
15.2cm (L W 6" H 3/8")

Rona Dorado  
Free Formed Carafe  
**4810R123** ●  
(1 qt) H 11 1/2"  
Not available in the EMEA

D.W. Haber  
Black Glass Rectangle Tile  
**DWFBGL2411BK** ●  
60.9cm x 27.9cm  
(L 24" W 11" H 3/8")

Steelite Performance  
Nyx Bowl  
**12050480** ●  
11.0cm (D 4 1/2" H 2") 34.0cl (12oz)

Creations Melamine  
Quarry Platter  
**7192TM304A** ●  
45.7 x 22.9 x 3.8cm  
(L 18" W 9" H 1 1/2")

D.W. Haber  
Black Teflon Riser  
**DW073124116BK** ●  
61.0 x 28.0 x 15.25cm  
(L 24" W 11" H 6")

D.W. Haber  
Black Glass Rectangle Tile  
**DWFBGL2411BK** ●  
60.9cm x 27.9cm  
(L 24" W 11" H 3/8")

Bormioli Rocco  
Bodega Mini  
**4912Q016** ●  
22.5cl (7 1/2oz),  
H 59mm (2 1/4"), Ø 82mm (3 1/4")  
Only available in the UK

Bormioli Rocco  
Ypsilon Shot Glass  
**4945Q426** ●  
7.0cl (2 1/4oz)  
H 107mm (4 1/4"), Ø 50mm (2")  
Only available in the UK

D.W. Haber  
Black Teflon Riser  
**DW073114143BK** ●  
35.6cm x 7.6cm (L W 14" H 3")

D.W. Haber Grey Wash Teak  
Wood Square Tile  
**DWFBWD1414SGW** ●  
35.6cm (L W 14")

Steelite Performance  
Craft Licorice FreeStyle Bowl  
**12090525** ●  
13.0cm (L 5" W 3 3/4" H 2 1/8")  
13.6cl (4 1/5oz)

● Stocked in European Warehouse

● Non-Stock



Expanding your hot buffet just got easier with stainless steel heat lamps from Creations. These fixed height lamps are available in both single and double heads, offer brilliant functionality and make a statement with any buffet presentation.



Portable Stainless Steel  
Modern Heat Lamp  
**7351MW310E2** • EU PLUG 220V  
**7351MW310E3** UK PLUG 220V  
Single Head H 22"



Portable Stainless Steel  
Modern Heat Lamp  
**7351MW311E2** • EU PLUG 220V  
**7351MW311E3** UK PLUG 220V  
Double Head H 22"

• Stocked In European Warehouse

All Single Head Lamps: 110v | 250 watt | 2.3 Amp • All Double Head Lamps: 110v | 500 watt | 4.5 Amp • Heat Lamp Bulb: Philips BR125 IR 250w E27 230-250V  
All lamps are 16" from table to lamp shade. For 220v Schuko plug add 'E2' to product code, for 220v UK plug add 'E3'. For AUS plug add 'E4'  
D=Diameter L=Length W=Width H=Height • All Products are Measured at Max Capacity (oz)



*a cut above the rest*

Designed to enhance the protein on your buffet service, D.W. Haber's carving boards and stands feature a well-built stainless steel frame and either butcher block, aluminium or granite options for the insert. The versatile 24x18" stands have interchangeable surfaces and feature a drip edge to catch any juices, while the Carving Extreme offers a catch basin to keep surrounding surfaces clean. In either case, your carving station will be elevated from the table, providing an enhanced catering presentation.



Boos Carving Board w/ Wood, Modern Frame  
**DW724MWSS** • 64.1cm x 45.7cm (25¼" x 18")



Carving Extreme w/Butcher Block  
**DW728R24SS** • 76.2cm (30")  
Seafood Extreme  
**DW728R24NSS** • 76.2cm (30")  
Round Maple Butcher Block w/Finger Grips  
**DW726WDFG25** • 61.0cm x 6.4cm H (24" x 2½" H)  
Must use Telescoping Lamp due to height

All 24" x 18" stands have interchangeable surfaces.

D=Diameter L=Length W=Width H=Height • All Products are Measured at Max Capacity (oz)

• Non-Stock



## Beverage & Cereal Dispensers

Beverage & cereal dispensers are essential for venues looking to create the ultimate buffet presentation. Steelite's Collection of 18/10 stainless steel beverage servers provide elegance & style, while the durability is tested and approved for commercial foodservice. The cereal dispensers help minimise waste and maintain cleanliness, creating that lasting impression that professional caterers desire.



Kenny Mack  
Carved Cup/Lid Holder  
**KMK1008ES** ●  
11.4cm (L W 4½" H 8")  
Espresso

D.W. Haber  
Grey Wash Teak Wood  
Square Tile  
**DWFBWD66SGW**  
15.2cm (L W 6")

Creations  
3-Tier Stand With Pipe Legs  
**6525T204**  
35.6cm x 66.0cm (D 14" H 26")  
Ebony

D.W. Haber  
Grey Wash Teak  
Wood Rectangle Tile  
**DWFBWD2411SGW**  
60.9cm x 27.9cm  
(L 24" W 11")

Folio Lucia  
Stack Soup Cup  
**4422RF014** ●  
D 4¼" H 2 ⅜" (10oz)

Creations Satin Base  
Insulated Coffee Pot  
**7502WL002** ●  
L 6" H 8¾" (51oz)  
**7502WL001** ●  
L 5¾" H 7 ⅜" (34oz)

D.W. Haber  
Black Teflon Riser  
**DW073124113BK**  
61.0 x 28.0 x 7.6cm  
(L 24" W 11" H 3")

Folio Lucia  
Stack Mug  
**4422RF023** ●  
L 4 ⅝" W 3¼"  
H 3¾" (12oz)

D.W. Haber  
Black Teflon Riser  
**DW0731664BK**  
15.2cm x 10.0cm  
(L W 6" H 4")

Folio Lucia  
Coupe Plate  
**4422RF070** ●  
D 6"

Bormioli Rocco  
Rock Bar Shot Glass  
**4939Q335**  
7.0cl (2¼oz)  
H 64mm (2½"), Ø 51mm (2")  
Only available in the UK

D.W. Haber Tower  
Vacuum Insulated Coffee Urns  
**DW33KTVACSS** ●  
38.1cm (L 15" W 14½" H 27") 11.4L (3gal)

D.W. Haber  
Square Drip Tray w/Drainer  
**DWDRIP5QSETSS** ●  
12.7cm (L W 5")

D.W. Haber  
Engraved ID Tents  
Mirror Stainless Steel  
**DWIDTENTCSS** ●  
Coffee 9.5cm (L 3¾" W 2¼")  
**DWIDTENTDSS** ●  
Decaf 9.5cm (L 3¾" W 2¼")  
**DWIDTENTHSS** ●  
Hot Water 9.5cm (L 3¾" W 2¼")

D.W. Haber Tower  
Vacuum Insulated Coffee Urns  
Textured Black  
**DW41KTVACBKSS** ●  
(L 14" W 14" H 23") 5.7L (1½gal)

Kenny Mack  
Carved Beverage  
Napkin Holder  
**KMK1010ES** ●  
15.2cm (L W 6" H 4")  
Espresso

Kenny Mack  
Carved Tea/Sugar  
Packet Holder  
**KMK1013ES** ●  
21.6cm (L 8½" W 9" H 2½")  
Espresso



**beverage service done right**

Serve warm beverages the right way with D.W. Haber's collection of coffee urns. Never worry about warm or burnt coffee with the vacuum insulated urns. The convenient vacuum technology keeps coffee at 165°F for five hours in a 5-gallon urn and over three hours in a 3-gallon urn without preheating. Urns are available with Tempo or Tower leg designs, and can be ordered as either fuel heated or vacuum sealed

**tower**



Tower Vacuum Insulated Coffee Urns  
**DW35KTVACSS** • 19L (5gal)  
 43.2cm (L 17" W 16½" H 31")  
**DW33KTVACSS** • 11.4L (3gal)  
 38.1cm (L 15" W 14½" H 27")  
**DW31KTVACSS** • 5.7L (1½gal)  
 35.6cm (L 14" W 14" H 23")



Tower Fuel Coffee Urns  
**DW35KSS** • 19L (5gal)  
 38.1cm (L 15" W 14½" H 27")  
**DW33KSS** • 11.4L (3gal)  
 35.6cm (L 14" W 14" H 23")  
**DW31KSS** • 5.7L (1½gal)  
 33.0cm (L 13" W 12" H 18¾")



Tower Vacuum Insulated Coffee Urns  
 Textured Black  
**DW45KTVACBKSS** • 19L (5gal)  
 43.2cm (L 17" W 16½" H 31")  
**DW43KTVACBKSS** • 11.4L (3gal)  
 38.1cm (L 15" W 14½" H 27")  
**DW41KTVACBKSS** • 5.7L (1½gal)  
 33.0cm (L 13" W 12" H 18¾")



Tower Fuel Coffee Urns  
 Textured White  
**DW45KWTSS** • 19L (5gal)  
 38.1cm (L 15" W 14½" H 27")  
**DW43KWTSS** • 11.4L (3gal)  
 35.6cm (L 14" W 14" H 23")  
**DW41KWTSS** • 5.7L (1½gal)  
 33.0cm (L 13" W 12" H 18¾")

**tempo**



Tempo Vacuum Insulated Coffee Urns  
**DW35WTVACSS** • 19L (5gal)  
 43.2cm (L 17" W 16" H 31")  
**DW33WTVACSS** • 11.4L (3gal)  
 38.1cm (L 15" W 14½" H 27")  
**DW31WTVACSS** • 5.7L (1½gal)  
 35.6cm (L 14" H 24")



Tempo Fuel Coffee Urns  
**DW35WSS** • 19L (5gal)  
 38.1cm (L 15" W 14½" H 27")  
**DW33WSS** • 11.4L (3gal)  
 35.6cm (L 14" W 14" H 23")  
**DW31WSS** • 5.7L (1½gal)  
 33.0cm (L 13" W 12" H 19")



Tempo Vacuum Insulated Coffee Urns  
 Textured White  
**DW45WTVACWTSS** • 19L (5gal)  
 43.2cm (L 17" W 16" H 31")  
**DW43WTVACWTSS** • 11.4L (3gal)  
 38.1cm (L 15" W 14½" H 27")  
**DW41WTVACWTSS** • 5.7L (1½gal)  
 35.6cm (L 14" H 24")



Tempo Fuel Coffee Urns  
 Textured Black  
**DW45WBKSS** • 19L (5gal)  
 38.1cm (L 15" W 14½" H 27")  
**DW43WBKSS** • 11.4L (3gal)  
 35.6cm (L 14" W 14" H 23")  
**DW41WBKSS** • 5.7L (1½gal)  
 33.0cm (L 13" W 12" H 19")

Pair with Hollowick Chafing Fuels. See pages 80-83 for more information.

**HWZE638** • Easy Heat 6-3-8 Hour • **HWPLUS6** • Ready Heat Plus 6 Hour • **HWREADY6** • Ready Heat 6 Hour • **BUFF624** • Buffet Heat 6 Hour

**air pot & cover-up**



Zojirushi Air Pot w/  
 Double Wall SS Liner  
**DW02823LZLPOTSS** • 3L (3qt)  
 22.9cm (L 9" W 7" H 17")



Modern Air Pot Cover-Up  
**DW02823LZLSS** •  
 30.5cm (L 12" W 10" H 15½")  
 For DW02823LZLPOTSS • (3qt)

Modern Cover-Up w/ Air Pot 2 pc. Set  
**DW02823LZLSSSET** • 27.9cm (11") (3qt)

**tents & card holders**



Engraved ID Tents Mirror Stainless Steel  
**DWIDTENTCSS** • Coffee 9.5cm (L 3¾" W 2¼")  
**DWIDTENTDSS** • Decaf 9.5cm (L 3¾" W 2¼")  
**DWIDTENTHSS** • Hot Water 9.5cm (L 3¾" W 2¼")  
**DWIDTENTXSS** • Blank 9.5cm (L 3¾" H 2¼")  
 Unlimited options for engraving on Tents (ex. Tea, Cream, Milk, etc.)

Freestanding Card Holder  
**DW07372SS** •  
 9.8cm (L 3⅞" W 2⅝")

**drip trays**



Drip Tray w/Drainer  
**DW30045SET** • D 13.4cm (5¼")



Square Drip Tray w/Drainer  
**DWDRIP50SETSS** • L W 12.7cm (5")



**Tempo Juicer**  
**DW12JLWSS** 11.4L (3gal)  
 30.5cm (L 12" W 10" H 25½")  
**DW07JLWSS** 6.6L (7qt)  
 27.9cm (L 11" W 11" H 20")  
**DW04JLWSS** 3.8L (4qt)  
 27.9cm (L 11" W 11" H 16")

**Tower Juicer**  
**DW12JLKSS** 11.4L (3gal)  
 30.5cm (L 12" W 10" H 25½") (3 gal)  
**DW07JLKSS** 6.6L (7qt)  
 27.9cm (L 11" W 11" H 20")  
**DW04JLKSS** 3.8L (4qt)  
 27.9cm (L 11" W 11" H 16")

**Millennium Juicer**  
**DW12JLDSS** 11.4L (3gal)  
 30.5cm (L 12" W 10" H 25½")  
**DW07JLDSS** 6.6L (7qt)  
 27.9cm (L 11" W 11" H 21¼")  
**DW04JLDSS** 3.8L (4qt)  
 27.9cm (L 11" W 11" H 17½")

*ash grey teak*



Juicer w/Ash Grey Teak Wood Base  
**DW12JLWDAG** 11.4L (3gal)  
**DW07JLWDAG** 6.6L (7qt)  
**DW04JLWDAG** 3.8L (4qt)

*grey wash teak*



Juicer w/Grey Wash Teak Wood Base  
**DW12JLWDGW** 11.4L (3gal)  
**DW07JLWDGW** 6.6L (7qt)  
**DW04JLWDGW** 3.8L (4qt)



*natural teak*



Juicer w/Natural Teak Wood Base  
**DW12JLWDT** 11.4L (3gal)  
**DW07JLWDT** 6.6L (7qt)  
**DW04JLWDT** 3.8L (4qt)

*beverage service done right*

Serve chilled beverages the right way with D.W. Haber's collection of juice dispensers. Available in Tempo, Tower, Millennium, and Fusion, the juicers have an ice sleeve in the centre to keep drinks chilled, and a universal base fits three different sized juice vessels.





*reducing the spread of germs*

Pouring a cup of coffee or juice just got easier with D.W. Haber's Touchless Taps. Simply press a cup against the dispenser to activate the flow and pull away once filled. The Touchless Plus is hands and drip-free, and its wide body targets the side of the glass and not the rim, which ultimately reduces the spread of germs. Made of 18/10 stainless steel, the spouts are resistant to rust and fit any D.W. Haber, and Creations urn or juicer on self-serve stations and buffets.

**touchless+**



Works on all D.W. Haber & WNK urns & juicers. Single point of contact reduces the spread of germs.

Touchless Plus Tap Handle  
**DWFCTHDL3DNTSS** ●  
10.2cm x 14.0cm h (4" x 5½" h)

**touchless**



Works on all D.W. Haber Fusion Buffet bases. Made of rust resistant 18/10 stainless steel.

Touchless Tap Handle for Fusion Buffet Bases  
**DWFCTHDL3WNTSS**  
7.6cm x 12.1cm h (3" x 4¾" h)

*refreshing infused beverages*

Add some modern flair to your buffet display with an acrylic juice dispenser from Creations. A square body is accompanied by a contemporary stainless steel stand that can be custom powder-coated to appeal to any style. With a central tube that works great as an infuser for flavoured beverages, these juicers will add a fresh look to buffets, lobbies, beverage stations and more.



Juice Dispenser with Stainless Steel Stand  
**7345MW305** ●  
L 10½" W 8½" H 20¾" (8qt)



**beautiful display, mess-free service**

Ideal for hotels, restaurants, and cafeterias, the Creations Cereal Dispensers feature an elongated tube to beautifully display and serve your favourite cereals. The rubber turn-style mechanism warrants a mess-free service, ensuring that the food won't crumble and helps control food cost. Find the perfect match for the cereal dispensers in the D.W. Haber Insulated Milk Dispensers. Available in Tempo, Tower or Millennium, these dispensers are designed with an ice sleeve that keeps milk at refrigerator temperature for over 5 hours.



**DW055MSS** ● Dispenser Only (No Stand) 5.2L (5½qt)  
**DW07JSTNDWDAG** Fusion Base Ash Grey Teak  
**DW07JSTNDWDT** ● Fusion Base Natural Teak  
**DW07JSTNDWDGW** Fusion Base Grey Wash Teak

*tempo*



Tempo Insulated Milk Dispenser w/ Ice Sleeve SS  
**DW055MLWSS** ●  
 5.2L (5½qt)  
 (L 11" W 11" H 20")  
 Keeps milk at refrigerator temperature for over 5 hours  
 Dispenser Only (No Stand)  
**DW055MSS** ●

*tower*



Tower Insulated Milk Dispenser w/ Ice Sleeve SS  
**DW055MLKSS** ●  
 5.2L (5½qt)  
 (L 11" W 11" H 20")  
 Keeps milk at refrigerator temperature for over 5 hours  
 Dispenser Only (No Stand)  
**DW055MSS** ●

*millennium*



Millennium Insulated Milk Dispenser w/ Ice Sleeve SS  
**DW055MLDSS** ●  
 5.2L (5½qt)  
 (L 11" W 11" H 20")  
 Keeps milk at refrigerator temperature for over 5 hours  
 Dispenser Only (No Stand)  
**DW055MSS** ●

CREATIONS *cereal dispensers* **creations**  
 BY STEELITE



Double Cereal Dispenser  
**7345MW117** ●  
 48.3 x 27.9 x 78.7cm H  
 (19" x 11" x 31" H)  
 11L (11.6qt) Per Cylinder



Single Cereal Dispenser  
**7345MW116** ●  
 31.8 x 24.8 x 78.7cm H  
 (12½" x 9¾" x 31" H)  
 11L (11.6qt)



*chilled to perfection*

D.W. Haber beverage & seafood chillers are designed for buffet and tableside service. With both single & double wall options, the wine coolers sit on their own stands to provide easy access for guests as well as a touch of elegance. While the larger beverage chillers and seafood extreme feature built in drains and double wall insulation to prevent sweating. In either case, the stainless steel construction is ultra durable and made to last!



Rectangular Beverage Tub Insulated Double Wall  
**DWTUB36187** ●  
91.4cm x 45.7 x 17.8cm H (36" x 18" x 7" H)



Seafood Extreme  
**DW728R24NSS** ●  
D 76.2cm (30")



Punch Bowl w/ Heavy Border SS  
**DW04052SS** ●  
47.0cm (18½") 19L (5gal)



Double Wall Beverage Extreme Mirror SS  
**DW0724TSETSS** ● D 61.0cm (24")  
Drainer for Beverage Extreme  
**DW0724TDRN3** ● D 61.0cm x 7.6cm H (24" x 3" H)

- Double wall means no sweat
- 24" diameter (fits 12 wine bottles)
- Includes low drain plate to seat wine bottles
- Optional 3" drainer for shallow beverages
- Capable for use with food or drink presentations
- Available in satin finish and mirror polish

D.W. HABER *wine coolers*



Wine Stand For Two Bottle  
Oval Scoop Cooler SS  
**DW040062VSS**  
40.6cm x 20.3cm H (16" x 8" H)  
Oval Scoop Wine Cooler 2 Bottle  
**DW040162VSS**  
26.7cm x 20.3cm (10½" x 8" H)



Wine Stand For Six Bottle  
Oval Scoop Cooler SS  
**DW040066VSS** ●  
Oval Scoop Wine Cooler 6 Bottle  
**DW040166VSS** ● 41.91cm (16½")



Wine Stand for Double Wine Cooler  
Double Wine Cooler, Ogee Border  
**DW040142SS** ●  
26.7cm x 24.1cm H (10½" x 9½" H)



Coaster/Underliner  
**DW30045** ●  
D 13.4cm (5¼") 10.2cm (4") Well



Coaster/Underliner  
**DW30044** ●  
D 13.4cm (5¼") 7.6cm (3") Well



The Creations brand includes a wide selection of metal accessories. From traditional round hammering, rice hammering and rim embossments to stainless steel and aluminium wire baskets, the Creations Metal collection has it all. Available in various finishes, shapes and sizes, Creations Metal provides that something extra every buffet or tabletop seeks.



Mirror Finish Water Pitcher  
**7345MW107** ●  
L 8" H 10½"  
(3½qts)



Satin Base Insulated Coffee Pot  
**7502WL002** ●  
L 6" H 8¾"  
(1¼qt)



Satin Base Insulated Coffee Pot  
**7502WL001** ●  
L 5¾" H 7¾"  
(1qt)



Wine Bucket  
**7600CV036** ●  
D 8¼" H 8¾"  
Wine Bucket Stand  
**7600CV037** ●  
L 9⅞" W 10⅞" H 28⅞"



Wine Stand  
**7600CV041** ●  
L 10¼" W 9½" H 28"



Wine Bucket Satin  
**7600CV040** ●  
D 7" H 8¼"



CREATIONS *party tub*

Party Tub  
**7600CV035** ●  
L 20¾" W 17¾" H 10¼" (7gal)

ROBERT WELCH *drift* *Robert Welch*



Wine/Champagne Bucket Stand  
**5977RW003**  
D 28.0cm H 64.0cm  
(D 11" H 25¼")

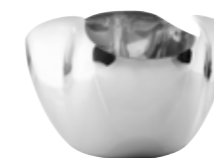

Wine/Champagne Cooler Large  
**5977RW020**  
(L 10⅝" W 16⅞" H 16⅞")



Double Wine/Champagne Bucket  
**5977RW002**  
L 28.0 W 21.5 H 23.0cm  
(L 11" W 8½" H 9")  
Single Wine/Champagne Bucket  
**5977RW001**  
L 23.5 W 19.0 H 21.0cm  
(L 8⅞" W 7½" H 8⅞")



Double Walled Wine/Champagne Cooler  
**5977RW013**  
L 13.6 W 13.4 H 22.4cm  
(L 5⅝" W 5¼" H 9")



Carved Tea/Sugar Packet Holder  
**KMK1013ES** ●  
21.6 x 22.9 x 6.4cm H  
(8½" x 9" x 2½" H) Espresso



Carved Cup/Lid Holder  
**KMK1008ES** ●  
11.4cm x 20.3cm (4½" x 8" H)  
Espresso



Carved Beverage Napkin Holder  
**KMK1010ES** ●  
15.2cm x 10.2cm H (6" x 4" H)  
Espresso



Carved Bar Napkin/Straw Holder  
**KMK1015ES** ●  
26.0 x 16.5 x 10.2cm H  
(10¼" x 6½" x 4" H)  
Espresso



Tea/Sugar Packet Holder  
**KMK1013SH** ●  
21.6 x 22.9 x 6.4cm H  
(8½" x 9" x 2½" H) Shell



Carved Cup/Lid Holder  
**KMK1008SH** ●  
11.4cm x 20.3cm (4½" x 8" H)  
Shell



Beverage Napkin Holder  
**KMK1010SH** ●  
15.2cm x 10.2cm H (6" x 4" H)  
Shell



Bar Napkin/Straw Holder  
**KMK1015SH** ●  
26.0 x 16.5 x 10.2cm H  
(10¼" x 6½" x 4" H)  
Shell



Carved Tea/Sugar Packet Holder  
**KMK1013TG** ●  
21.6 x 22.9 x 6.4cm H  
(8½" x 9" x 2½" H) Tangerine



Carved Cup/Lid Holder  
**KMK1008TG** ●  
11.4cm x 20.3cm (4½" x 8" H)  
Tangerine

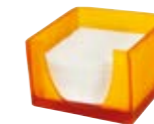

Carved Beverage Napkin Holder  
**KMK1010TG** ●  
15.2cm x 10.2cm H (6" x 4" H)  
Tangerine



Candle Holder Oval  
8.9cm x 8.9cm (3½" x 3½" H)  
**KMK2409SBICE** ● Sky Blue Ice  
**KMK2409ICESH** ● Ice Shell  
**KMK2409TGP** ● Tangerine Pearl  
**KMK2409TOR** ● Tortoise

*unique designs for the table & beyond*

Accessorise your beverage service display with resin solutions by Kenny Mack. Featuring precisely designed holders for napkins, coffee cups or lids, straws, tea packets and more, these highly durable accessory items are available in 3 colours and provide unique display opportunity for foodservice.



## Induction, Chafing Fuel & Burners

Commercial catering is easier with induction solutions from Steelite. The best alternative to open flame, induction technology utilises magnetic currents to heat pots, pans & chafing dishes to provide a safe & efficient cooking experience. Induction gives any foodservice operator the flexibility to host a variety of events, ensuring that food is cooked & served at the right temperature for maximum enjoyment.



**cordless warming induction for use anywhere**

The D.W. Haber Power Cell is a revolutionary solution for keeping food hot for extended periods of time. The sleek and elegant design makes it a stylish addition to buffets & food stations, and its cordless battery operation allows it to be used anywhere. The Power Cell has a 6-hour recharge time so it can be used for multiple meals per day, and it is a cost-saving solution as it compares to repetitive purchases of chafing fuel. The first of its kind, this induction unit is energy-efficient and operates quietly, ensuring that it won't disturb the ambiance of the setting.



d.w.haber  
**POWERCELL**



Power Cell Cordless Induction Range - Patent-Pending  
220V EU & UK Plug  
**DWELINPCE2E3** ● L 37.1cm x W 33.0cm (L 14<sup>5</sup>/<sub>8</sub>" W 13" H 3")  
Travel Case  
**DWELINPCCASE** ● L 19" W 15<sup>7</sup>/<sub>8</sub>" H 7<sup>1</sup>/<sub>8</sub>"



Power Cell Cover Up  
Ash Grey Teak  
**DWFB15133WDAG** ●  
L 42.8 x W 38.1 x H 9.5cm (L 16<sup>7</sup>/<sub>8</sub>" W 15" H 3<sup>3</sup>/<sub>4</sub>")



Power Cell Cover Up  
Natural Teak  
**DWFB15133WDT** ●  
L 42.8 x W 38.1 x H 9.5cm (L 16<sup>7</sup>/<sub>8</sub>" W 15" H 3<sup>3</sup>/<sub>4</sub>")



Power Cell Cover Up  
Grey Wash Teak  
**DWFB15133WDGW** ●  
L 42.8 x W 38.1 x H 9.5cm (L 16<sup>7</sup>/<sub>8</sub>" W 15" H 3<sup>3</sup>/<sub>4</sub>")



Induction Warmer 300 Watt  
34.3 x 31.8 x 11.4cm H  
(13½" x 12½" x 4½" H)  
300w/220V  
Adapter required with induction  
when using with a riser  
**DWELIN300BE2** ● EU Plug  
**DWELIN300BE3** UK Plug



Induction Range 1800 Watt  
34.3 x 31.8 x 11.4cm H  
(13½" x 12½" x 4½" H)  
1800w/220V  
Adapter required with induction  
when using with a riser  
**DWELIN1800BE2** ● EU Plug  
**DWELIN1800BE3** UK Plug

*butane cover up*



Modern Butane Cover-Up w/Grill  
**DW0281MGSS** ●  
Fits all Hollowick Butane Stoves  
**CMST-9K\*** ● 9,000 BTU Portable Stove  
**CMST-10K\*** ● 10,000 BTU Portable Stove  
**CMST-15K\*** ● 15,000 BTU Portable Stove

\* **WARNING:** This product can expose you to chemicals including carbon monoxide emissions, which is known to the State of California to cause cancer and birth defects. For more info go to [www.P65Warnings.ca.gov](http://www.P65Warnings.ca.gov)

D=Diameter L=Length W=Width H=Height • All Products are Measured at Max Capacity (oz)

● Non-Stock ● Stocked in European Warehouse





**maximum heat performance**

The proper placement of any chafing fuel source is critically important to have maximum heat performance. With Hollowick Easy Heat® Chafing Fuels, the wick is adjustable to accommodate different temperature levels and the can stays cool for easy handling. Simply adjust the wick to change the heat output between standard, low and high, then place on the fuel holder or table beneath to properly heat the chafing dish.

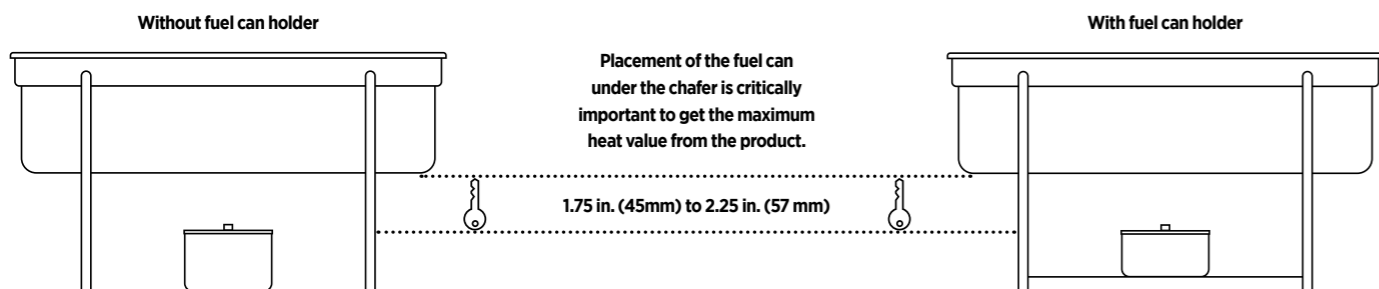

**consistent flame & adjustable heat**

Easy Heat® liquid chafing fuels are the go-to choice for buffet service. With a consistent flame for even heat, the wicks are located outside the canister keeping the flame position the same as it burns and the can cool so servers can easily handle during service. The wicks are also easily adjustable to provide different levels of heat to suit operator needs. Comprised of Diethylene Glycol, Hollowick's Easy Heat® fuels are non-flammable and enclosed in a sealed canister to prevent spill accidents and reuse on separate occasions.



**HWZE638** • Case: 24  
**HWZE6386PK** • Case: 6  
 Burn Time: 6-3- or 8 hours

**3 HEAT SETTINGS**  
 Standard 6 hr  
 High 3 hr  
 Low 8 hr



**HWZE425** •  
 Burn Time: 4-2- or 5 hours  
 Case: 24

**3 HEAT SETTINGS**  
 Standard 4 hr  
 High 2 hr  
 Low 5 hr



**HWZE213** •  
 Burn Time: 2-1- or 3 hours  
 Case: 48

**3 HEAT SETTINGS**  
 Standard 2 hr  
 High 1 hr  
 Low 3 hr

• Non-stock item. Due to shipping restrictions, all non-stock liquid candles and fuel-based items can only be purchased on a minimum order quantity basis and will be shipped directly from Hollowick, USA.  
 D=Diameter L=Length W=Width H=Height • All Products are Measured at Max Capacity (oz)



**xtreme heat®**

*larger, hotter flame*

Xtreme Heat® by Hollowick burns hotter than gel fuels with its specially designed wick that provides larger and hotter flame. Featuring a pop top, Xtreme Heat® burns clean and contains a safe non-flammable liquid.



**HWXTRM424** ●  
Burn Time: 4 hours  
Case: 24



**buffet heat**

*clean burning, no odour*

Buffet Heat liquid chafing fuel offers medium heat in 6, 4 and 2-hour can sizes. Containing a convenient resealable lid to allow use on separate occasions, Buffet Heat is ideal for a chafer and other food warming needs.



**HWBUFF624** ●  
Burn Time: 6 hours  
Case: 24



**HWBUFF4** ●  
Burn Time: 4 hours  
Case: 24



**HWBUFF2** ●  
Burn Time: 2 hours  
Case: 24



**ready heat**

*easy-off screw top*

Keep food warm with Hollowick Ready Heat chafing fuel. Offering medium heat in 3 can sizes, this non flammable liquid fuel can is resealable and always cool to the touch, making service convenient & simple.



**HWREADY6** ●  
Burn Time: 6 hours  
Case: 24



**HWREADY4** ●  
Burn Time: 4 hours  
Case: 24



**HWREADY2** ●  
Burn Time: 2 hours  
Case: 48



**ready heat plus**

*can stays cool during service*

Ready Heat Plus is a superior chafing fuel that burns as hot as gel, and provides an easy-off screw top to easily reseal and reuse. This chafing fuel is made of safe, non flammable liquid and burns clean with no odour.



**HWPLUS6** ●  
Burn Time: 6 hours  
Case: 24



**HWPLUS4** ●  
Burn Time: 4 hours  
Case: 24



**HWPLUS2** ●  
Burn Time: 2 hours  
Case: 72



**value heat**

*the economical choice for food warming*

Value Heat from Hollowick provides a safe, value conscious solution for food warming. Its non-flammable liquid burns clean without odour and comes in three can sizes: 6, 4 and 2 hour burn time.



**HWVALUE6** ●  
Burn Time: 6 hours  
Case: 24



**HWVALUE4** ●  
Burn Time: 4 hours  
Case: 24



**HWVALUE2** ●  
Burn Time: 2 hours  
Case: 48



**hot 5**

*easy to use, value priced*

Hollowick Hot 5 is a specifically designed for easy use; simply remove the cap and light. Intended for five hours of burn time, Hot 5's fuel can is safely sealed, therefore the can is safe & cool to handle at any point.



**HWHOT524** ●  
Burn Time: 5 hours  
Case: 24



● Non-stock item. Due to shipping restrictions, all non-stock liquid candles and fuel-based items can only be purchased on a minimum order quantity basis and will be shipped directly from Hollowick, USA.  
D=Diameter L=Length W=Width H=Height • All Products are Measured at Max Capacity (oz)



## Custom Powder Coating

Create a unique buffet presentation with custom powder coat options on our stainless steel buffetware. Available in a textured or hammered finish and a wide variety of colours, high temperature powder coat is durable, dishwasher safe, hides fingerprints and creates a new fresh look on any buffet.



*custom powder coating*

Powder Coating is a popular option for buffet products in the commercial foodservice industry. It's a type of coating that is applied as a free-flowing, dry powder to the surface of a product. Powder coating creates a hard, durable finish that is resistant to scratches, chipping and fading, making it ideal for high volume use and a demanding buffet service environment. It also enables operators to tailor the colour & finish of chafing dishes, urns, or heat lamps to match their brand or decór. Available in a vast selection of colours or finishes, create a professional and cohesive look on any buffet service with custom powder coating. Contact us today to learn more!



*endless colour options*



*add a textured finish*



*two tone options available*



Tempo Fuel Coffee Urns  
Textured White  
**DW45WWTSS** ● 19L (5gal)  
**DW43WWTSS** ● 11.4L (3gal)  
**DW41WWTSS** ● 5.7L (1½gal)

Tempo Vacuum Insulated Coffee Urns  
Textured Black  
**DW45WTVACBKSS** ● 19L (5gal)  
**DW43WTVACBKSS** ● 11.4L (3gal)  
**DW41WTVACBKSS** ● 5.7L (1½gal)

For further details and a full offering of available options contact your customer service rep.  
D=Diameter L=Length W=Width H=Height • All Products are Measured at Max Capacity (oz)



## Visual Display

Creating a visually appealing buffet display is crucial in the foodservice industry, as it is the first impression that guests will have of the food & service. At Steelite, we offer professional caterers the right tools to create the perfect presentation every time. From rustic teak wood to modern, black teflon risers and acrylic bakery boxes to gastronomic platters, the possibilities are endless to create a well-crafted visual display.

*sophistication for any setting*

The Fusion Buffet System is a unique and versatile solution for your foodservice presentation. With multi-sized risers, juicers, and baskets, you can mix and match your display with the numerous wood & metal finishes available. Designed from reclaimed wood, the teak products are environmentally friendly and cost effective, while its natural properties make it resistant to heat, light and moisture. Resin, tempered glass or teak wood tiles can also be used to add new heights, while the 14" risers can be outfitted with universal inserts that make cooking and heating easier.

*finish options available*

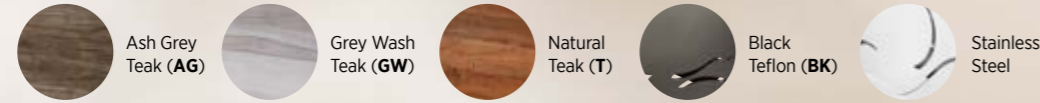

Folio Azores  
Caldeira Plate  
**6213FA001**  
D 25.5cm (10")  
Not available in the UK

D.W. Haber  
Black Tower Heater Stand w/Aluminium Plate  
**DW04H202KBK** ●  
50.8cm (L 20" W 14")

D.W. Haber  
Black Card Holder for Metal Fusion  
**DW07372BK** ●  
9.8cm (L 3 7/8" W 2 3/8")

Folio Azores  
Caldeira Plate  
**6213FA003**  
D 15.25cm (6")  
Not available in the UK

D.W. Haber  
Serving Tong  
**DW396ST9**  
22.9cm ( 9 1/4")

D.W. Haber  
Cover Holder  
**DW396CVRHOLD1** ●  
Satin SS Adapter Clip  
**DWFB14CLIPHOLD1** ●

D.W. Haber  
Black Hanging Card  
Holder for Wood Risers  
**DW07373HK2BK** ●  
9.8cm (L 3 7/8" W 2 3/8")

D.W. Haber  
Ash Grey Fusion Buffet Riser Gastronom  
**DWFB20127WDAG** 58.4 x 38.1 x 18.4cm (L 23" W 15" H 7 1/4")

D.W. Haber Fusion Grill for Gastronom Riser Stainless Steel  
**DWFB20GRILL** ● (L 21 1/4" W 13 1/4")  
Fusion Fuel Shelf for Gastronom Riser Stainless Steel  
**DWFB20SHELF** ● (L 14 1/2" W 4")  
Fuel Holder **DW01001** ●

Creations Chafer Round Brushed Stainless  
**7352MW301** ● 3.8L (4qts) 38.1 x 31.8 x 12.7cm (L 15" W 12 1/2" H 5")  
**7352MW300** 1.9L (2qts) 30.5 x 25.4 x 12.7cm (L 12" W 10" H 5")

D.W. Haber Ash Grey 3 Piece Riser Set  
**DWRISERS3WDAG**  
58.4cm (L 23" W 6") in 3 Heights: 1 1/2", 3 1/2", 5 1/2"

Folio Oval Mini Crock **6977QU013**  
17.8 x 12 x 4.5cm (L 7" x W 4 3/4" x H 1 3/4") 43.6cl (14.75oz)

Folio Bryce **5731SX001** ● Teaspoon (6 1/4")

D.W. Haber  
Ash Grey Square Riser  
**DWFB612WDAG**  
15.2cm x 30.5cm (L W 6" H 12")

D.W. Haber  
Black Glass Square Tile  
**DWFBGL12BK** ●  
30.5cm (L W 12" H 3 1/8")

Rona Stellar Shot Glass  
**4802R261** ● (1 1/4oz)

D.W. Haber Black Card Holder  
**DW07372BK** ●  
9.8cm (L 3 7/8" W 2 3/8")

D.W. Haber  
Ash Grey Square Riser  
**DWFB66WDAG**  
15.2cm x 15.2cm (L W 6" H 6")

D.W. Haber  
Black Glass Square Tile  
**DWFBGL6BK** ●  
15.2cm (L W 6" H 3 1/8")

D.W. Haber  
Juicer w/ Ash Grey  
Teak Wood Base  
**DW12JLWDAG** 11.4L (12qt)

D.W. Haber  
Drip Tray w/Drainer  
**DW30045SET** ●  
D 13.4cm (5 1/4")

Folio  
Jewel Rocks  
**6460BW030** ● (12 1/2oz)

D.W. Haber  
Juicer w/ Ash Grey  
Teak Wood Base  
**DW07JLWDAG** 6.6L (7qt)



Steelite Performance  
Vesuvius Coupe Plate  
**12010567** ● D 20.25cm (8")

D.W. Haber  
Natural Teak Square Riser  
**DWFB66WDT** ●  
15.2cm x 15.2cm (L W 6" H 6")

D.W. Haber  
Black Glass Square Tile  
**DWFBGL6BK** ●  
15.2cm (L W 6" H 3/8")

D.W. Haber  
**DW396ST9**  
Serving Tong 22.9cm (9")

Steelite Performance  
Ink Nomad Blue Coupe Plate  
**17620568**  
D 15.25cm (6")

Folio Alpha-Ceram  
Serving Bowl  
**6959E6132** ●  
(D 15" H 4") (5qt)

D.W. Haber  
Black Glass Rectangle Tile  
**DWFBGL241BK** ●  
60.9cm x 27.9cm  
(L 24" W 11" H 3/8")

Steelite Performance  
Aurora Revolution Tulip Bowl  
**17800541** ●  
17.5cm (D 7" H 3 1/4") 106.0cl (37.3oz)

D.W. Haber  
Natural Teak Square Riser  
**DWFB612WDT** ●  
15.2cm x 30.5cm (L W 6" H 12")

D.W. Haber  
Black Glass Square Tile  
**DWFBGL6BK** ●  
15.2cm (L W 6" H 3/8")

Steelite Performance  
Revolution Essence Bowl  
**17770597**  
16.5cm (D 6 1/2" H 2 3/8")  
58.5cl (20.6oz)

Steelite Performance  
Aurora Revolution Bowl  
**17800481** ●  
D 13.5cm (5 1/4") 45.5cl (16oz)

D.W. Haber  
Black Glass Rectangle Tile  
**DWFBGL2407BK** ●  
60.9cm x 17.8cm (L 24" W 7" H 3/8")  
**DWFBGL241BK** ●  
60.9cm x 27.9cm (L 24" W 11" H 3/8")

D.W. Haber  
Natural Teak Square Riser  
**DWFB612WDT** ●  
15.2cm x 30.5cm (L W 6" H 12")

D.W. Haber  
Black Glass Square Tile  
**DWFBGL6BK** ●  
15.2cm (L W 6" H 3/8")

D.W. Haber  
Stackable Sauceboat  
**DW8011SS** ● 32.5cl (11oz)  
24.1cm (L 9 1/2" W 4" H 3 1/4")

D.W. Haber  
Black Glass Rectangle Tile  
**DWFBGL241BK** ●  
60.9cm x 27.9cm (L 24" W 11" H 3/8")

Folio Alpha-Ceram  
Platter Rectangle  
**6959E6135** ●  
(L 18 1/2" W 10 1/2" H 1 1/4")

Folio Alpha-Ceram  
Crock  
**6959E6133** ●  
(D 6" H 7") (2qt)  
**6959E6137** ●  
(D 5" H 5 1/2") (1qt)

D.W. Haber  
Natural Teak Square Riser  
**DWFB66WDT** ●  
15.2cm x 15.2cm  
(L W 6" H 6")

D.W. Haber  
Black Glass Square Tile  
**DWFBGL6BK** ●  
15.2cm (L W 6" H 3/8")

● Stocked in European Warehouse

● Non-Stock



Steelite Performance  
Urban Coupe Plate  
**12080567**  
D 20.25cm (8")

D.W. Haber Rectangle Black HomeStyle Chafer  
**DW04QCWG8BK** ●  
(L 13¼" W 11½") 3.8L (4qt)

D.W. Haber  
Gastronorm Buffet Riser  
**DWFB20127WDGW**  
58.4 x 38.1 x 18.4cm (L 23" W 15" H 7¼")

D.W. Haber  
Fusion Grill for Gastronorm Riser  
Stainless Steel  
**DWFB20GRILL** ● (L 21¼" W 13¼")

D.W. Haber  
Fusion Fuel Shelf for Gastronorm Riser  
Stainless Steel  
**DWFB20SHELF** ● (L 14½" W 4")  
Fuel Holder  
**DW01001** ●

D.W. Haber  
Black Hanging Card Holder  
for Wood Risers  
**DW07373HK2BK** ●  
9.8cm (L 3⅞" W 2⅜")

D.W. Haber  
Hammered Serving Tong  
**DW396ST9**  
22.9cm (9¼")

Steelite Performance  
Craft Licorice Coupe Plate  
**12090568** ● D 15.25cm (6")

Creations  
Royce Teapot w/Lid  
**7347MW148** ●  
(17oz)

D.W. Haber Square Riser  
**DWFB612WDGW**  
15.2cm x 30.5cm (L W 6" H 12")

D.W. Haber Black Glass  
Square Tile  
**DWFBGL6BK** ●  
15.2cm (L W 6" H ⅜")

D.W. Haber  
Black Card Holder  
**DW07372BK** ●  
9.8cm (L 3⅞" W 2⅜")

Kenny Mack  
Slant Bowl Shell  
**KMK1025SH** ●  
20.3cm (D 8" H 6") (1qt)

D.W. Haber  
Square Riser  
**DWFB66WDGW**  
15.2cm x 15.2cm  
(L W 6" H 6")

D.W. Haber  
Black Glass Square Tile  
**DWFBGL6BK** ●  
15.2cm (L W 6" H ⅜")

Steelite Performance  
Taste Bowl  
**11070633** 56.75cl (20oz)  
12.0cm (D 4¾" H 3")

D.W. Haber  
3 Piece Riser Set  
**DWRISERS3WDGW**  
58.4cm (L 23" W 6")  
in 3 Heights: 1½", 3½", 5½"

D.W. Haber  
Tower Round Chafer Full Glass Lid  
**DW06KH7SS** ● 7.5L (2gal)  
44.5cm (L 17½" W 18" H 12")

D.W. Haber  
Divided Round Food Pan  
**DW06RFP2**  
38.7cm (D 15½" H 3")  
7.5L (2gal)

D.W. Haber Fuel Holder **DW01001** ●

D.W. Haber  
Black Card Holder  
**DW07372BK** ●  
9.8cm (L 3⅞" W 2⅜")

Steelite Performance  
Craft Licorice Coupe Plate  
**12090568** ●  
D 15.25cm (6")

D.W. Haber  
Gastronorm Buffet Riser  
**DWFB20127WDGW** ●  
58.4 x 38.1 x 18.4cm (L 23" W 15" H 7¼")  
(Fits EL590, EL591)

D.W. Haber  
Bakery Split Cover  
**7345MW150** ●  
54.6cm x 34.9cm (L 21½" W 13¾")

D.W. Haber  
Ice Bin for Gastronorm Risers  
**DW08WP6PL** ●  
(L 20⅞" W 12¾" H 6")

Bormioli Rocco  
Emilia Swing Top Bottle  
**49137Q472** 50.0cl (17oz)  
H 210mm (8¼"), Ø 74mm (3")  
Only available in the UK

● Stocked in European Warehouse

● Non-Stock





D.W. Haber  
Gastronorm Buffet Riser  
**DWFB20127WDT** ●  
58.4 x 38.1 x 18.4cm (L 23" W 15" H 7¼")  
(Fits EL590, EL591)

D.W. Haber Bakery Split Cover  
**7345MW150** ●  
54.6cm x 34.9cm (L 21½" W 13¾")

D.W. Haber Ice Bin for Gastronorm Risers  
**DW08WP6PL** ●  
(L 20⅞" W 12¾" H 6")

Bormioli Rocco  
Ypsilon Carafe  
**4945Q939** 114.0cl (38½oz)  
H 215mm (8½"), Ø 115mm (4½")  
Only available in the UK

D.W. Haber Stainless Steel Hanging Card Holder  
for Fusion Wood Risers  
**DW07373HK2SS**  
9.8cm (L 3⅞" W 2⅜")



D.W. Haber  
Carrera Resin Square Tile  
**DWKFB1212CAR** ● 30.5cm (L W 12" H ¾")

D.W. Haber Black Universal Shelf Holder for  
Teak Fusion Risers  
**DWFBUSHT4** ●

Folio Lucia  
Coupe Plate  
**4422RF070** ● (D 6")



D.W. Haber  
Gastronorm Buffet Riser  
**DWFB20127WDT** ●  
58.4 x 38.1 x 18.4cm (L 23" W 15" H 7¼")

D.W. Haber  
Ice Cell  
**DWFB20ICESET** ●  
Set Includes 1 Tray, 2 Cooling Blocks and 2 Buffer Pouches  
Gastronorm Platter Sold Separately  
**DWFBGN1** ●  
Gastronorm White Rectangle Platter 1/1

D.W. Haber  
Stainless Steel Hanging Card Holder for Fusion Wood Risers  
**DW07373HK2SS**  
9.8cm (L 3⅞" W 2⅜")



D.W. Haber  
Angled Square Bread Basket  
**DWFBWDBASK1ST** ●  
35.6cm (L W 14")

D.W. Haber  
Stainless Steel Riser  
**DW073114145SS** ●  
35.6cm x 12.75cm (L W 14" H 5")



Creations  
Double Cereal Dispenser  
**7345MW117** ●  
48.3 x 27.9 x 78.7cm (L 19" W 11" H 31")  
11L (11.6 qt Per Cylinder)

Folio Lucia  
Stack Soup Cup  
**4422RF014** ●  
(D 4¼" H 2⅜") (10oz)

D.W. Haber Stainless Steel  
Freestanding Card Holder  
**DW07372SS** ●  
9.8cm (L 3⅞" W 2⅜")



D.W. Haber  
Insulated Milk Dispenser w/ Ice Sleeve  
**DW055MSS** ● (5½qt)

D.W. Haber  
Fusion Base Natural Teak  
**DW07JSTNDWDT** ●

D.W. Haber  
Square Drip Tray w/Drainer  
**DWDRI5QSETSS** ● 12.7cm (L W 5")

Folio Lucia  
Stack Soup Cup  
**4422RF014** ●  
(D 4¼" H 2⅜") (10oz)



D.W. Haber  
Black Tower  
Heater Stand Frame  
**DW08H40KFRMBK** ●  
101.6cm x 35.6cm  
(L 40" W 14")

D.W. Haber  
Maple Carving  
Board  
**DW04H202CB34** ●  
50.8cm (L 20" W 14" H ¾")

D.W. Haber  
Heater Stand Aluminium  
Plate w/Groove  
**DW04H202ALUM** ●  
50.8cm (L 20" W 14")

D.W. Haber  
Grey Wash Square Riser  
**DWFB147WDGW**  
35.6cm x 17.8cm (L W 14" H 7")

D.W. Haber  
Round Black HomeStyle Chafer  
**DW06CWG8BK** ●  
7.5L (2gal) (L 14" W 3½" H 6")

D.W. Haber  
Induction Warmer 300 Watt  
**DWELIN300BE2** ● EU Plug  
**DWELIN300BE3** ● UK Plug  
34.3cm (L 13½" W 12½" H 4½")

Black Fusion Induction Adapter Ring  
**DWFB14ADAPBK** ●  
35.6cm (14")

D.W. Haber  
Grey Wash Square Riser  
**DWFB612WDGW**  
15.2cm x 30.5cm  
(L W 6" H 12")

D.W. Haber  
Black Glass Square Tile  
**DWFBGL6BK** ●  
15.2cm (L W 6" H ¾")

D.W. Haber  
Black Glass Rectangle Tile  
**DWFBGL241BK** ●  
60.9cm x 27.9cm  
(L 24" W 11" H ¾")

Steelite Performance  
Nyx Bowl  
**12050480** ●  
11.0cm (D 4½" H 2") 34.0cl (12oz)

Creations Melamine  
Quarry Platter  
**7192TM304A** ●  
45.7 x 22.9 x 3.8cm  
(L 18" W 9" H 1½")

D.W. Haber  
Black Teflon Riser  
**DW073124116BK**  
61.0 x 28.0 x 15.25cm  
(L 24" W 11" H 6")

D.W. Haber  
Black Glass Rectangle Tile  
**DWFBGL241BK** ●  
60.9cm x 27.9cm  
(L 24" W 11" H ¾")

Bormioli Rocco  
Bodega Mini  
**4912Q016** 22.5cl (7½oz)  
H 59mm (2¼"), Ø 82mm (3¼")  
Only available in the UK

Bormioli Rocco  
Ypsilon Shot Glass  
**4945Q426** 7.0cl (2¼oz)  
H 107mm (4¼"), Ø 50mm (2")  
Only available in the UK

D.W. Haber  
Black Teflon Riser  
**DW073114143BK** ●  
35.6cm x 7.6cm  
(L W 14" H 3")

D.W. Haber Grey Wash Teak  
Wood Square Tile  
**DWFBWD1414SGW**  
35.6cm (L W 14")

Steelite Performance  
Craft Licorice FreeStyle Bowl  
**12090525** ●  
13.0cm (L 5" W 3¾" H 2⅛")  
13.6cl (4⅔oz)

● Stocked in European Warehouse

● Non-Stock



Folio Azores  
Costa Plate  
**6210FA002**  
D 20.25cm (8½")  
Not available in the UK

D.W. Haber Round Black HomeStyle Chafer  
**DW06CWG8BK** ●  
7.5L (2gal) (L 14" W 3½" H 6")

D.W. Haber Square Riser Natural Teak  
**DWFB147WDT** ●  
35.6cm x 17.8cm (L W 14" H 7")

D.W. Haber Square Grill  
**DWFB14GRILL** ● L W 35.6cm (14")

D.W. Haber Fuel Holder **DW01001** ●

D.W. Haber Black Hanging Card Holder  
**DW07373HK2BK** ● 9.8cm (L 3⅞" W 2⅜")

D.W. Haber Cover Holder  
**DW396CVRHOLD1** ● 27.7cm x 11.4cm (11" x 4½")  
Satin SS Adapter Clip  
**DWFB14CLIPHOLD1** ●

D.W. Haber  
Black Glass Square Tile  
**DWFBGL12BK** ●  
30.5cm (L W 12" H ¾")

Folio Bryce  
Long Serving Spoon  
**5731SX062** 27.3cm (10¾")

D.W. Haber  
Spoon Rest  
**DW394SR** 13.4cm (5¼")

D.W. Haber  
Black Shelf Holder  
**DWFBUSHT4** ●

D.W. Haber  
Round Black HomeStyle Chafer  
**DW04CWG8BK** ●  
30.0cm x 9.0cm (L 11¼" W 3½" H 6")  
3.8L (4qt)

D.W. Haber Induction Range  
1800 Watt  
34.3 x 31.8 x 11.4cm H (L 13½" W 12½" H 4½")  
**DWELIN1800BE2** ● EU Plug  
**DWELIN1800BE3** UK Plug

D.W. Haber Black Fusion  
Induction Adapter Ring  
**DWFB14ADAPBK** ● 35.6cm (14")  
(Required for Induction when  
used with the 14" teak risers)

D.W. Haber Black Hanging Card Holder  
**DW07373HK2BK** ●  
9.8cm (L 3⅞" W 2⅜")



D.W. Haber Tower Round Chafer Full Glass Lid  
**DW06KH7SS** ●  
44.5cm (L 17½" W 18" H 12") 7.5L (2gal)

D.W. Haber Divided Round Food Pan  
**DW06RFP2**  
38.7cm (D 15¼" H 3") 7.5L (2gal)

Folio Bryce Long Serving Spoon  
**5731SX062** 27.3cm (10¾")

Folio Bryce Large Tong  
**5731SX073** 25.4cm (10")

D.W. Haber Spoon Rest  
**DW394SR** 13.4cm (5¼")

D.W. Haber Fuel Holder **DW01001** ●

D.W. Haber Rectangle Tile Natural Teak  
**DWFBWD2411ST** ●  
60.9cm x 27.9cm (L 24" W 11")

D.W. Haber Black Card Holder  
**DW07372BK** ● 9.8cm (L 3⅞" W 2⅜")

Steelite Performance  
Revolution Coupe Plate  
**17760568** D 15.25cm (6")

D.W. Haber Serving Tong  
**DW396ST9**  
22.9cm (9")

Kenny Mack  
Jagged Edge Bowl  
**KMK2083ES** ●  
33.0cm (D 13" H 4½")  
Espresso

Ypsilon Carafe  
**4945Q412** 107.5cl (36¼oz)  
H 255mm (10"), Ø 102mm (4")  
Only available in the UK

Creations Melamine  
Slate Rectangle Gastronom Platter  
**68A415EL593** ●  
325mm x 265mm (L 12¾" W 10½")  
**68A415EL595** ●  
325mm x 176mm (L 12¾" W 7")

● Stocked in European Warehouse

● Non-Stock



D.W. Haber Round Stainless Steel HomeStyle Chafer  
**DW04CWG8SS** ● 3.8L (4qt)  
 30.0cm x 9.0cm H  
 (11<sup>1</sup>/<sub>8</sub>" x 3<sup>1</sup>/<sub>2</sub>" H)

D.W. Haber White Round Porcelain Food Pan  
**DW64RFPPOR** ●  
 30.5cm (12") 3.8L (4qt)  
 D.W. Haber Square Riser  
**DWFB145WDAG**  
 35.6cm x 12.7cm (L W 14" H 5")

D.W. Haber Black Card Holder  
**DW07373HK2BK** ●  
 9.8cm (L 3<sup>7</sup>/<sub>8</sub>" W 2<sup>3</sup>/<sub>8</sub>" H)

D.W. Haber Square Grill  
**DWFB14GRILL** ●  
 L W 35.6cm (14")

D.W. Haber Cover Holder  
**DW396CVRHOLD1** ●  
 Satin SS Adapter Clip  
**DWFB14CLIPHOLD1** ●  
 D.W. Haber Black Shelf Holder  
**DWFBUSHT4** ●

D.W. Haber Square Riser  
**DWFB66WDAG**  
 15.2cm x 15.2cm  
 (L W 6" H 6")

D.W. Haber Black Glass Tile  
**DWFBGL12BK** ●  
 30.5cm  
 (L W 12" H 3<sup>3</sup>/<sub>8</sub>" H)

D.W. Haber Black Glass Tile  
**DWFBGL6BK** ●  
 15.2cm  
 (L W 6" H 3<sup>3</sup>/<sub>8</sub>" H)

D.W. Haber Spoon Rest  
**DW394SR**  
 13.4cm (5<sup>1</sup>/<sub>4</sub>" H)

Folio Bryce Small Tong  
**5731SX074**  
 17.8cm (7")

D.W. Haber Round SS HomeStyle Chafer  
**DW04CWG8SS** ● 3.8L (4qt)  
 30.0cm x 9.0cm H (11<sup>1</sup>/<sub>8</sub>" x 3<sup>1</sup>/<sub>2</sub>" H)

D.W. Haber White Round Porcelain Food Pan  
**DW64RFPPOR** ● 30.5cm (12") 3.8L (4qt)

D.W. Haber Fusion Buffet Riser Gastronorm  
**DWFB20127WDAG**  
 58.4 x 38.1 x 18.4cm (L 23" W 15" H 7<sup>1</sup>/<sub>4</sub>" H)

D.W. Haber Fusion SS Grill for Gastronorm Riser  
**DWFB20GRILL** ●  
 (L 21<sup>1</sup>/<sub>4</sub>" W 13<sup>1</sup>/<sub>4</sub>" H)



Steelite Performance Craft White FreeStyle Bowl  
**11550523** ●  
 28.0cm (L 11" W 9<sup>1</sup>/<sub>2</sub>" H)  
 87.25cl (30.7oz)

Varick Fulton Vintage Copper  
**5735** 18/0

Steelite Performance Craft White FreeStyle Bowl  
**11550525** ●  
 13.0cm (5") 13.6cl (4<sup>1</sup>/<sub>2</sub>oz)

Steelite Performance Craft White Rectangle Tray  
**11550556** ●  
 33.0cm x 19.0cm (L 13" W 7<sup>1</sup>/<sub>2</sub>" H)



D.W. Haber Stackable Bakery Box with Acrylic Drawer  
**DWFBWDBDAG** ●  
 (L 14" W 8<sup>1</sup>/<sub>2</sub>" H 8")

D.W. Haber Black Glass Rectangle Tile  
**DWFBGL2411BK** ●  
 60.9cm x 27.9cm (L 24" W 11" H 3<sup>3</sup>/<sub>8</sub>" H)  
**DWFBGL2407BK** ●  
 60.9cm x 17.8cm L 24" W 7" H 3<sup>3</sup>/<sub>8</sub>" H

D.W. Haber Bread Tray w/Applied Border  
**DW1609** ●  
 22.9cm (L 9")

D.W. Haber Square Riser  
**DWFB147WDAG**  
 35.6cm x 17.8cm (L W 14" H 7")

D.W. Haber Square Flat Basket  
**DWFBWDBASK2SAG**  
 35.6cm (L W 14")  
 Hinged Acrylic Lid  
**DWFB14CVRH** ● (LW 14") Clear



Folio Azores Costa Plate  
**6210FA002**  
 D 20.25cm (8 1/4")  
 Not available in the UK

D.W. Haber  
 Grey Marble Resin Tile  
**DWKFB1212GM**  
 30.5cm (L W 12" H 3/8")

D.W. Haber Polished SS Riser  
**DW07311212SS**  
 30.5cm x 5.0cm (L W 12" H 2")

D.W. Haber Ash Grey Teak  
 Fusion Buffet Riser Gastronorm  
**DWFB20127WDAG**  
 58.4 x 38.1 x 18.4cm (L 23" W 15" H 7 1/4")

Creations Melamine  
 Craft White Rectangle Platter  
**68A416EL591**  
 530mm x 325mm (L 21" W 12 3/4")

D.W. Haber Bakery Split Cover  
**7345MW150**  
 54.6cm x 34.9cm (L 21 1/2" W 13 3/4")

D.W. Haber Ash Grey Teak  
 Square Riser  
**DWFB147WDAG**  
 35.6cm x 17.8cm (L W 14" H 7")

D.W. Haber  
 Fusion Aluminium Square Bowl  
**DWFCAB19W**  
 48.3cm (L W 19" H 4")

D.W. Haber Fido Clear Jar  
**4949Q458** (7 3/4oz)

D.W. Haber Black Shelf Holder  
**DWFBUSHT4**

D.W. Haber  
 Grey Marble Resin Tile  
**DWKFB1414GM**  
 35.6cm (L W 14" H 3/8")

D.W. Haber Ash Grey Teak  
 Square Riser  
**DWFB612WDAG**  
 15.2cm x 30.5cm (L W 6" H 12")

D.W. Haber  
 Grey Marble Resin Tile  
**DWFB666GM**  
 15.2cm (L W 6" H 3/8")

D.W. Haber Ash Grey Teak  
 Angled Square Bread Basket  
**DWFBWDBASK1SAG**  
 35.6cm (L W 14")

D.W. Haber Ash Grey Teak  
 Square Riser  
**DWFB145WDAG**  
 35.6cm x 12.7cm (L W 14" H 5")

D.W. Haber Ash Grey Teak  
 Square Riser  
**DWFB66WDAG**  
 15.2cm x 15.2cm (L W 6" H 6")

D.W. Haber Ash Grey Teak  
 Wood Square Tile  
**DWFBWD66SAG**  
 L W 15.2cm (6")



*ash grey teak*



Square Riser  
**DWFB147WDAG**  
35.6cm x 17.8cm (L W 14" H 7")



Square Riser  
**DWFB145WDAG**  
35.6cm x 12.7cm (L W 14" H 5")



Fusion Buffet Riser Gastronorm  
**DWFB20127WDAG\***  
58.4 x 38.1 x 18.4cm H (23" x 15" x 7 1/4" H)  
(Fits EL590, EL591 Gastronorm Trays)



Low Profile Gastronorm Riser **NEW**  
**DWFB21132WDAG\*** ●  
58.4 x 38.1 x 7.9cm (L 23" W 15" H 3 1/8")  
(Fits EL590, EL591 Gastronorm Trays & DWFB20ICESET Ice Cell)



Rectangle Tile  
**DWFBWD2411SAG**  
60.9cm x 27.9cm (L 24" W 11")



Square Tile  
**DWFBWD1414SAG** 35.6cm (L W 14")  
**DWFBWD1212SAG** 30.5cm (L W 12")  
**DWFBWD1111SAG** 27.9cm (L W 11")  
**DWFBWD66SAG** 15.2cm (L W 6")



3 Piece Riser Set  
**DWRISERS3WDAG**  
58.4cm (L 23" W 6")  
in 3 Heights: 1 1/2", 3 1/2", 5 1/2"



Square Riser  
**DWFB116WDAG**  
27.9cm x 15.2cm (L W 11" H 6")  
Square Grill  
**DWFB11GRILL** ● 27.9cm (L W 11")



Square Riser  
**DWFB612WDAG**  
15.2cm x 30.5cm (L W 6" H 12")



Square Riser  
**DWFB66WDAG**  
15.2cm x 15.2cm (L W 6" H 6")



Angled Square Bread Basket  
**DWFBWDBASK1SAG**  
35.6cm (L W 14")



Square Flat Basket  
**DWFBWDBASK2SAG**  
35.6cm (L W 14")



Stackable Bakery Box with Acrylic Drawer  
**DWFBWDBDAG** ● **NEW**  
36.2cm x 21.6cm (L 14 1/4" x W 8 1/2" H 8")



Universal stand fits 3 size containers

Juicer w/Ash Grey Teak Wood Base  
**DW12JLWDAG** 11.4L (12qt)  
Juicer w/Ash Grey Teak Wood Base  
**DW07JLWDAG** 6.6L (7qt)  
Juicer w/Ash Grey Teak Wood Base  
**DW04JLWDAG** 3.8L (4qt)



\*All Creations Gastronorm Trays fit in the Fusion Buffet Gastronorm Risers.

D=Diameter L=Length W=Width H=Height • All products are measured at max capacity. See pages 123-125 for all Fusion Buffet insert options.

See pages 123-125 for all Fusion Buffet insert options.

D=Diameter L=Length W=Width H=Height • All Products are Measured at Max Capacity (oz)

● Non-Stock ● Stocked in European Warehouse



*grey wash teak*



Square Riser  
**DWFB147WDGW**  
35.6cm x 17.8cm (L W 14" H 7")



Square Riser  
**DWFB145WDGW**  
35.6cm x 12.7cm (L W 14" H 5")



Gastronorm Buffet Riser  
**DWFB20127WDGW**<sup>^</sup>  
58.4 x 38.1 x 18.4cm H (23" x 15" x 7 1/4" H)  
(Fits EL590, EL591 Gastronorm Trays)



Low Profile Gastronorm Riser **NEW**  
**DWFB21132WDGW**<sup>^</sup> ●  
58.4 x 38.1 x 7.9cm (L 23" W 15" H 3 1/8")  
(Fits EL590, EL591 Gastronorm Trays & DWFB20ICESET Ice Cell)



Rectangle Tile  
**DWFBWD2411SGW**  
60.9cm x 27.9cm (L 24" W 11")



Square Tile  
**DWFBWD1414SGW** 35.6cm (L W 14")  
**DWFBWD1212SGW** 30.5cm (L W 12")  
**DWFBWD1111SGW** 27.9cm (L W 11")  
**DWFBWD666SGW** 15.2cm (L W 6")



3 Piece Riser Set  
**DWRISERS3WDGW**  
58.4cm (L 23" W 6")  
in 3 Heights: 1 1/2", 3 1/2", 5 1/2"



Square Riser  
**DWFB116WDGW**  
27.9cm x 15.2cm (L W 11" H 6")  
Square Grill  
**DWFB11GRILL** ● 27.9cm (L W 11")



Square Riser  
**DWFB612WDGW**  
15.2cm x 30.5cm  
(L W 6" H 12")



Square Riser  
**DWFB666WDGW**  
15.2cm x 15.2cm  
(L W 6" H 6")



Square Bread Basket Angled  
**DWFBWDBASK1SGW**  
35.6cm (L W 14")



Square Flat Basket  
**DWFBWDBASK2SGW**  
35.6cm (L W 14")



Stackable Bakery Box with Acrylic Drawer **NEW**  
**DWFBWDBDGW** ●  
36.2cm x 21.6cm  
(L 14 1/4" x W 8 1/2" H 8")



Universal stand fits 3 size containers

- Juicer w/Grey Wash Teak Wood Base  
**DW12JLWDGW** 11.4L (12qt)
- Juicer w/Grey Wash Teak Wood Base  
**DW07JLWDGW** 6.6L (7qt)
- Juicer w/Grey Wash Teak Wood Base  
**DW04JLWDGW** 3.8L (4qt)



<sup>^</sup>All Creations Gastronorm Trays fit in the Fusion Buffet Gastronorm Risers.

D=Diameter L=Length W=Width H=Height • All products are measured at max capacity. See pages 123-125 for all Fusion Buffet insert options.

See pages 123-125 for all Fusion Buffet insert options.

D=Diameter L=Length W=Width H=Height • All Products are Measured at Max Capacity (oz)

● Non-Stock ● Stocked in European Warehouse



*natural teak*



Square Riser  
**DWFB147WDT** ●  
35.6cm x 17.8cm (L W 14" H 7")



Square Riser  
**DWFB145WDT** ●  
35.6cm x 12.7cm (L W 14" H 5")



Gastronorm Buffet Riser  
**DWFB20127WDT** ●  
58.4 x 38.1 x 18.4cm H (23" x 15" x 7 1/4" H)  
(Fits EL590, EL591 Gastronorm Trays)



Low Profile Gastronorm Riser **NEW**  
**DWFB21132WDT** ●  
58.4 x 38.1 x 7.9cm (L 23" W 15" H 3 1/8")  
(Fits EL590, EL591 Gastronorm Trays & DWFB20ICESET Ice Cell)



Rectangle Tile  
**DWFBWD2411ST** ●  
60.9cm x 27.9cm (L 24" W 11")



Square Tile  
**DWFBWD1414ST** ● 35.6cm (L W 14")  
**DWFBWD1212ST** ● 30.5cm (L W 12")  
**DWFBWD1111ST** ● 27.9cm (L W 11")  
**DWFBWD66ST** ● 15.2cm (L W 6")



3 Piece Riser Set  
**DWRISERS3WDT** ●  
58.4cm (L 23" W 6")  
in 3 Heights: 1 1/2", 3 1/2", 5 1/2"



Square Riser  
**DWFB116WDT** ●  
27.9cm x 15.2cm (L W 11" H 6")  
Square Grill  
**DWFB11GRILL** ● 27.9cm (L W 11")



Square Riser  
**DWFB612WDT** ●  
15.2cm x 30.5cm  
(L W 6" H 12")



Square Riser  
**DWFB66WDT** ●  
15.2cm x 15.2cm  
(L W 6" H 6")



Angled Square Bread Basket  
**DWFBWDBASK1ST** ●  
35.6cm (L W 14")



Square Flat Basket  
**DWFBWDBASK2ST** ●  
35.6cm (L W 14")



Stackable Bakery Box  
with Acrylic Drawer **NEW**  
**DWFBWDBDT** ●  
36.2cm x 21.6cm  
(L 14 1/4" x W 8 1/2" H 8")



Universal stand fits 3 size containers

- Juicer w/Natural Teak Wood Base  
**DW12JLWDT** ● 11.4L (12qt)
- Juicer w/Natural Teak Wood Base  
**DW07JLWDT** ● 6.6L (7qt)
- Juicer w/Natural Teak Wood Base  
**DW04JLWDT** ● 3.8L (4qt)



\*All Creations Gastronorm Trays fit in the Fusion Buffet Gastronorm Risers.

D=Diameter L=Length W=Width H=Height • All products are measured at max capacity. See pages 123-125 for all Fusion Buffet insert options.

See pages 123-125 for all Fusion Buffet insert options.

D=Diameter L=Length W=Width H=Height • All Products are Measured at Max Capacity (oz)

● Non-Stock ● Stocked in European Warehouse





**black teflon** Proprietary black teflon coating eliminates finger prints and gives a unique feel to the Fusion Buffet System.

**stainless steel**

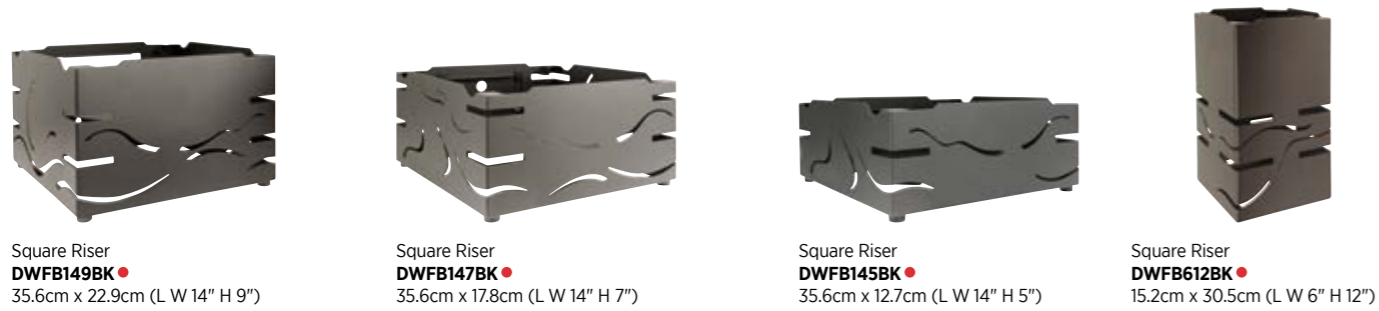

Square Riser  
**DWFB149BK** ●  
35.6cm x 22.9cm (L W 14" H 9")

Square Riser  
**DWFB147BK** ●  
35.6cm x 17.8cm (L W 14" H 7")

Square Riser  
**DWFB145BK** ●  
35.6cm x 12.7cm (L W 14" H 5")

Square Riser  
**DWFB612BK** ●  
15.2cm x 30.5cm (L W 6" H 12")

Square Riser  
**DWFB149** ●  
35.6cm x 22.9cm (L W 14" H 9")

Square Riser  
**DWFB147** ●  
35.6cm x 17.8cm (L W 14" H 7")

Square Riser  
**DWFB145** ●  
35.6cm x 12.7cm  
(L W 14" H 5")

Square Riser  
**DWFB612** ●  
15.2cm x 30.5cm  
(L W 6" H 12")

Fusion Ice Box w/Plastic Insert  
**DWFB20128P** ●  
50.8cm (L 20" W 12" H 8")

**mini riser grill stands**



Mini Riser w/ Grill  
**DWGB99GBK** ●  
22.9cm  
(L W 9" H 9")

Mini Riser w/ Grill  
**DWGB76GBK** ●  
19.0cm  
(L W 7½" H 6")

Design an elevated juicer station with built-in features such as two different heights, three interchangeable size juice vessels, all-metal taps, a centre ice well to keep juice cold, and reversible risers for dual use.



Juicer  
**DW12JLFBMOD7SS** ●  
L 12" W 12" H 25"  
13.6L (12qt) (H 7" Stand)

Juicer  
**DW07JLFBMOD7SS** ●  
L 12" W 12" H 21"  
8.5L (7¼qt) (H 7" Stand)

Juicer  
**DW04JLFBMOD7SS** ●  
L 12" W 12" H 17"  
4.5L (4qt) (H 7" Stand)

Juicer  
**DW12JLFBMOD9SS** ●  
L 12" W 12" H 27"  
13.6L (12qt) (H 9" Stand)

Juicer  
**DW07JLFBMOD9SS** ●  
L 12" W 12" H 23"  
8.5L (7¼qt) (H 9" Stand)

Juicer  
**DW04JLFBMOD9SS** ●  
L 12" W 12" H 20"  
4.5L (4qt) (H 9" Stand)

See pages 123-125 for all Fusion Buffet insert options.

D=Diameter L=Length W=Width H=Height • All Products are Measured at Max Capacity (oz)

● Non-Stock



*black teflon risers*

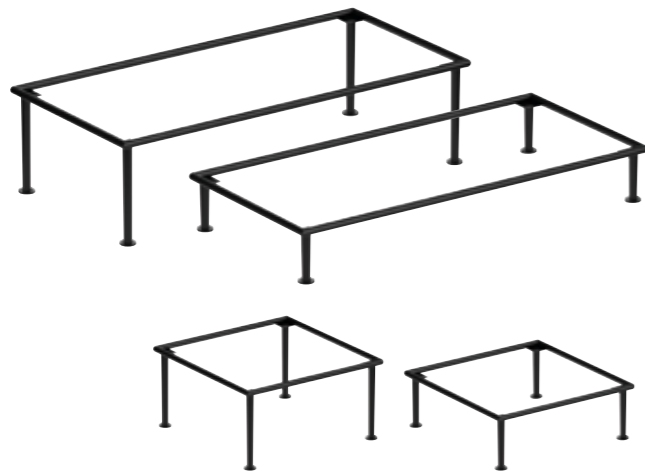

Black Teflon Riser  
**DW073124116BK**  
61.0 x 28.0 x 15.25cm  
(L 24" W 11" H 6")

Black Teflon Riser  
**DW073124113BK**  
61.0 x 28.0 x 7.6cm  
(L 24" W 11" H 3")

Black Teflon Riser  
**DW073112126BK**  
30.5cm x 15.25cm  
(L W 12" H 6")

Black Teflon Riser  
**DW073112124BK**  
30.5cm x 10.0cm  
(L W 12" H 4")

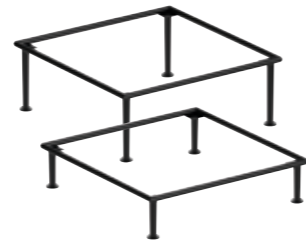

Black Teflon Riser  
**DW073114145BK** ●  
35.6cm x 12.75cm  
(L W 14" H 5")

Black Teflon Riser  
**DW073114143BK** ●  
35.6cm x 7.6cm  
(L W 14" H 3")

Black Teflon Riser  
**DW0731666BK**  
15.2cm x 15.2cm  
(L W 6" H 6")

Black Teflon Riser  
**DW0731664BK**  
15.2cm x 10.0cm  
(L W 6" H 4")



*polished stainless steel risers*

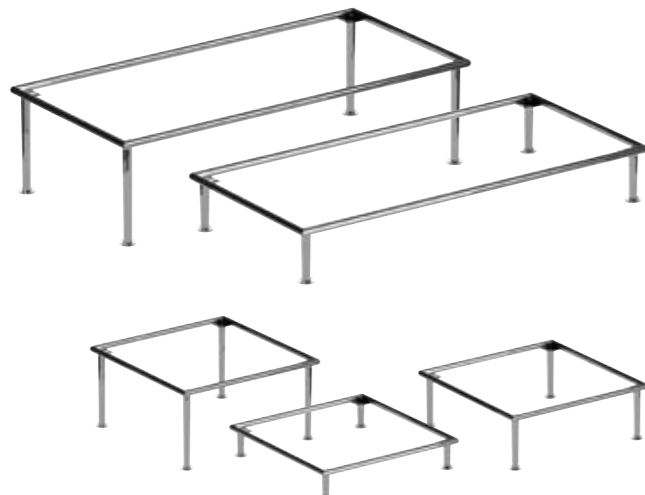

Polished SS Riser  
**DW073124116SS**  
61.0 x 28.0 x 15.25cm  
(L 24" W 11" H 6")

Polished SS Riser  
**DW073124113SS**  
61.0 x 28.0 x 7.6cm  
(L 24" W 11" H 3")

Polished SS Riser  
**DW073112126SS**  
30.5cm x 15.25cm  
(L W 12" H 6")

Polished SS Riser  
**DW073112124SS**  
30.5cm x 10.0cm  
(L W 12" H 4")

Polished SS Riser  
**DW073112122SS**  
30.5cm x 5.0cm  
(L W 12" H 2")

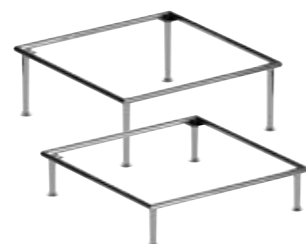

Polished SS Riser  
**DW073114145SS** ●  
35.6cm x 12.75cm  
(L W 14" H 5")

Polished SS Riser  
**DW073114143SS**  
35.6cm x 7.6cm  
(L W 14" H 3")



Polished SS Riser  
**DW0731666SS**  
15.2cm x 15.2cm  
(L W 6" H 6")

Polished SS Riser  
**DW0731664SS**  
15.2cm x 10.0cm  
(L W 6" H 4")



*resin tiles & shelves*

Resin tiles are durable, non-absorbent, and food and dishwasher safe.



*wood tiles & shelves*

Durable teak wood



*glass tiles & shelves*

Tempered glass

*elevate your buffet presentation*

The perfect addition to the Fusion Buffet System are the black Teflon and stainless steel square and rectangle risers. These multi-sized, elevated frames offer beauty and height for your presentation, and are presented with interchangeable inserts in resin, teak wood and tempered glass.

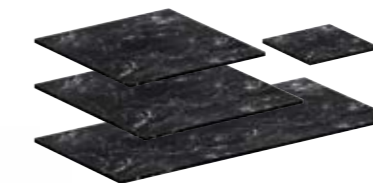

Grey Marble Resin Square Tile  
**DWKFBI414GM** 35.6cm (L W 14" H 3/8")  
**DWKFBI212GM** 30.5cm (L W 12" H 3/8")  
**DWKFBI66GM** 15.2cm (L W 6" H 3/8")  
Grey Marble Resin Rectangle Tile  
**DWKFBI2411GM** 60.9cm x 27.9cm (L 24" W 11" H 3/8")

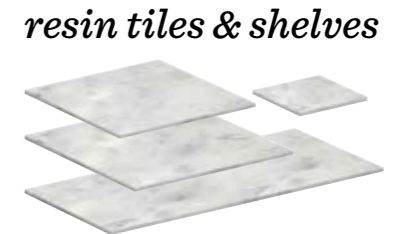

Carrera Resin Square Tile  
**DWKFBI414CAR** 35.6cm (L W 14" H 3/8")  
**DWKFBI212CAR** 30.5cm (L W 12" H 3/8")  
**DWKFBI66CAR** 15.2cm (L W 6" H 3/8")  
Carrera Resin Rectangle Tile  
**DWKFBI2411CAR** 60.9cm x 27.9cm (L 24" W 11" H 3/8")

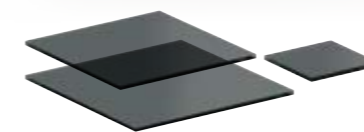

Black Glass Square Tile  
**DWFBGL14BK** 35.6cm (L W 14" H 3/8")  
**DWFBGL12BK** 30.5cm (L W 12" H 3/8")  
**DWFBGL6BK** 15.2cm (L W 6" H 3/8")  
Black Glass Rectangle Tile  
**DWFBGL3611BK** 91.4cm x 27.9cm (L 36" W 11" H 3/8")  
**DWFBGL3607BK** 91.4cm x 17.8cm (L 36" W 7" H 3/8")  
**DWFBGL2411BK** 60.9cm x 27.9cm (L 24" W 11" H 3/8")  
**DWFBGL2407BK** 60.9cm x 17.8cm (L 24" W 7" H 3/8")



Clear Glass Square Tile  
**DWFBGL14** 35.6cm (L W 14" H 3/8")  
**DWFBGL6** 15.2cm (L W 6" H 3/8")  
Clear Glass Rectangle Tile  
**DWFBGL3611** 91.4cm x 27.9cm (L 36" W 11" H 3/8")  
**DWFBGL3607** 91.4cm x 17.8cm (L 36" W 7" H 3/8")  
**DWFBGL2411** 60.9cm x 27.9cm (L 24" W 11" H 3/8")  
**DWFBGL2407** 60.9cm x 17.8cm (L 24" W 7" H 3/8")



Frosted Glass Square Tile  
**DWFBGL14F** 35.6cm (L W 14" H 3/8")  
**DWFBGL12F** 30.5cm (L W 12" H 3/8")  
**DWFBGL6F** 15.2cm (L W 6" H 3/8")  
Frosted Glass Rectangle Tile  
**DWFBGL2411F** 60.9cm x 27.9cm (L 24" W 11" H 3/8")

*wood tiles tiles & shelves*



Ash Grey Teak Wood Square Tile  
**DWFBWD1414SAG** 35.6cm (L W 14")  
**DWFBWD1212SAG** 30.5cm (L W 12")  
**DWFBWD1111SAG** 27.9cm (L W 11")  
**DWFBWD66SAG** 15.2cm (L W 6")  
Ash Grey Teak Wood Rectangle Tile  
**DWFBWD2411SAG** 60.9cm x 27.9cm (L 24" W 11")



Grey Wash Teak Wood Square Tile  
**DWFBWD1414SGW** 35.6cm (L W 14")  
**DWFBWD1212SGW** 30.5cm (L W 12")  
**DWFBWD1111SGW** 27.9cm (L W 11")  
**DWFBWD66SGW** 15.2cm (L W 6")  
Grey Wash Teak Wood Rectangle Tile  
**DWFBWD2411SGW** 60.9cm x 27.9cm (L 24" W 11")



Natural Teak Wood Square Tile  
**DWFBWD1414ST** 35.6cm (L W 14")  
**DWFBWD1212ST** 30.5cm (L W 12")  
**DWFBWD1111ST** 27.9cm (L W 11")  
**DWFBWD66ST** 15.2cm (L W 6")  
Natural Teak Wood Rectangle Tile  
**DWFBWD2411ST** 60.9cm x 27.9cm (L 24" W 11")

See pages 123-125 for all Fusion Buffet insert options.

D=Diameter L=Length W=Width H=Height • All Products are Measured at Max Capacity (oz)

● Non-Stock ● Stocked in European Warehouse

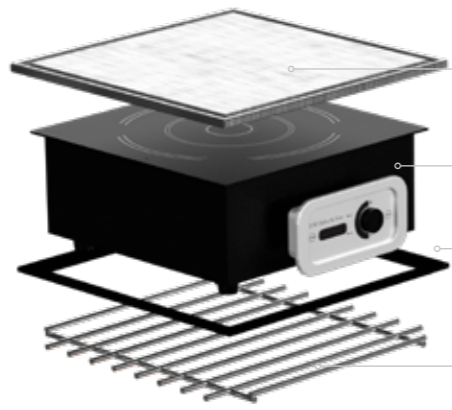

**hot buffet**

- Aluminium Hot Plate**  
DWFB14ALUM ●  
For use with metal risers only
- Induction Ready**  
DWELIN300B Warmer 300 Watt (2.5 amp, 120v)  
DWELIN1800B Range 1800 Watt (15 amp, 120v)
- Black Induction Adapter Ring**  
DWFB14ADAPBK ●  
Required for Induction when used with the 14" teak risers
- Square Grill**  
DWFB14GRILL ●



**ambient buffet**

- Hinged Acrylic Lid**  
DWFB14CVRH ●
- Flat Wood Basket**  
DWFBWDBASK2SAG Ash Grey Teak  
Also available as angled wood basket  
Available in three finishes:  
Grey Wash, Ash Grey & Natural Teak
- Square Tiles**  
DWKFB1414GM Grey Marble Resin  
Available in wood, glass and resin



**cold buffet**

- Aluminium Square Bowl**  
Available in two heights:  
DWFCAB19W ● L W 19" H 4"  
DWFCAB16W ● L W 16" H 2"
  - Aluminium Divided Square Bowl**  
DWFCAB16DW ● L W 16" H 2"
  - Square Wood Riser**  
DWFB147WDAG Ash Grey Teak L W 14" H 7"  
DWFB145WDAG Ash Grey Teak L W 14" H 5"  
Available in three finishes:  
Grey Wash, Ash Grey & Natural Teak
- Also Available: **Square Metal Riser**  
Available in three heights: 5", 7" and 9"  
Available in two finishes:  
Stainless Steel & Black Teflon

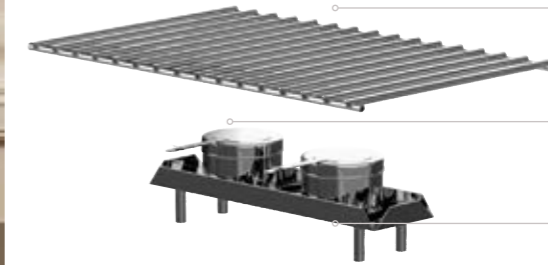

**hot buffet**

- Stainless Steel Fusion Grill**  
for Gastronorm Riser  
DWFB20GRILL ● L 21½" W 13¼"
- Fuel Holder DW01001 ●**
- Fusion Fuel Shelf**  
for Gastronorm Riser Stainless Steel  
(Fuel Holders Not Included)  
DWFB20SHELF ● L 14½" W 4"



**ambient buffet**

- Bakery Split Cover**  
7345MW150 ●  
L 21½" W 13¾"
- Slate Rectangle Platter**  
68A415EL591 ● L 21" W 12¾"  
Available in: Slate, Driftwood & Craft White



**cold buffet**

- DWFBGN1 ●**  
Ice Cell Gastronorm  
White Rectangle Platter 1/1 **NEW**
  - DWFB20ICESET ●**  
Ice Cell Set **NEW**  
Set Includes 1 Tray,  
2 Cooling Blocks and  
2 Buffer Pouches
  - Ice Bin for Gastronorm Risers**  
DW08WP6PL ●  
L 20 7/8" W 12 3/4" H 6"
  - Fusion Buffet Riser Gastronorm**  
DWFB20127WDAG  
Ash Grey Teak L 23" W 15" H 7¼"  
Available in three finishes:  
Grey Wash, Ash Grey & Natural Teak
- Also Available:
- Low Profile Gastronorm Riser ● NEW**  
L 23" W 15" H 3 1/8"  
Available in three finishes: Grey Wash,  
Ash Grey & Natural Teak



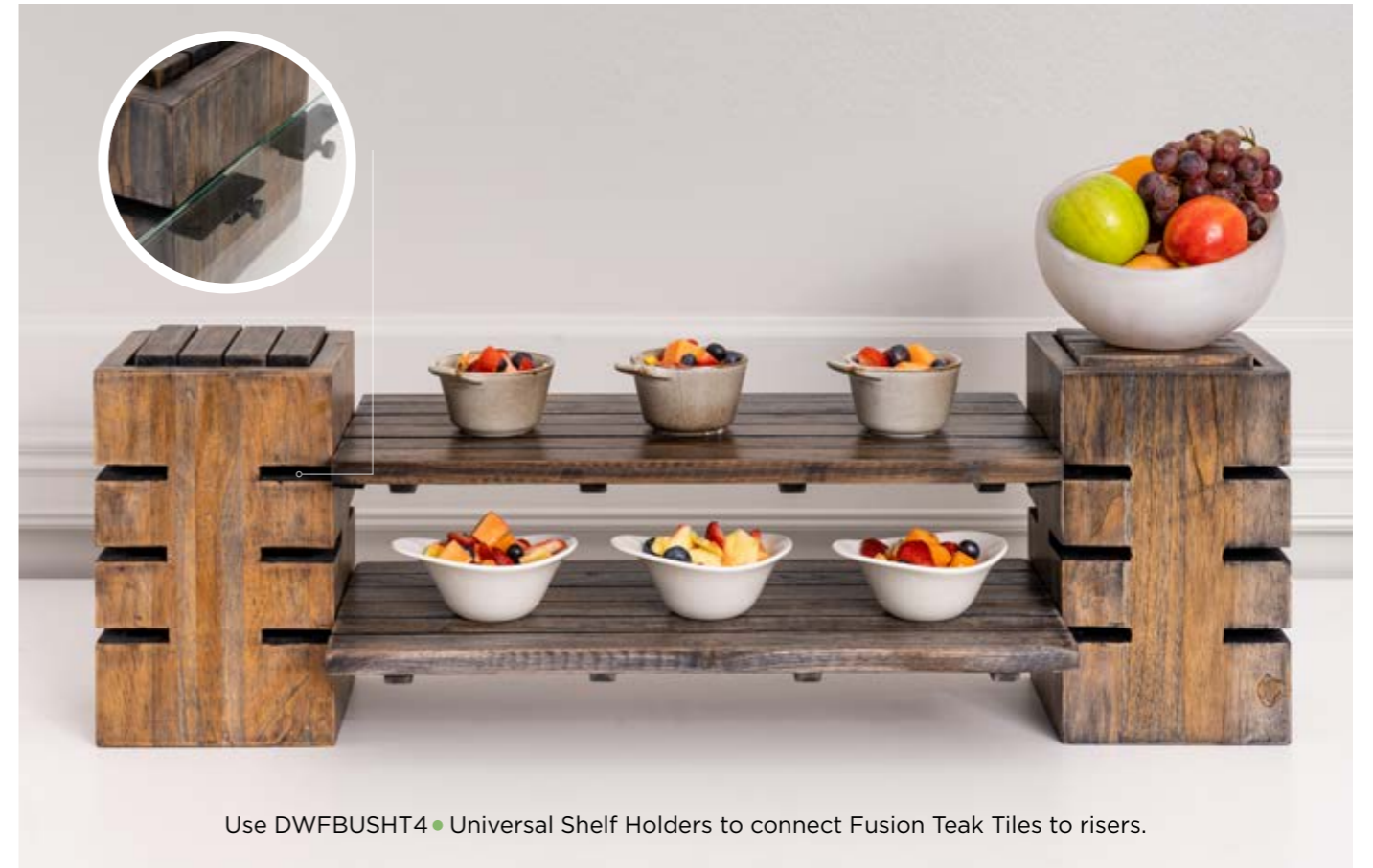

Use DWFBUSHT4 • Universal Shelf Holders to connect Fusion Teak Tiles to risers.



Use the corner notches on the risers to insert Fusion Tiles at 3 different heights on a 45° angle.



*introducing the d.w. haber ice cell*

The perfect solution for keeping your buffet food fresh and chilled for extended periods! This innovative chilling system is designed to keep food cold for at least 3 hours, ensuring freshness and quality. Keeping food at the right temperature is crucial to prevent bacterial growth and maintain its taste and texture. The D.W. Haber Ice Cell is specifically designed to fit the standard and low profile Fusion Gastronom risers, available in 3 finishes: Ash Grey, Grey Wash, and Natural Teak wood.



1. Store the cooling blocks in the freezer overnight for the best results.



2. Place the cooling blocks in the BPA free tray, and set the temperature equalisers on top of the blocks to maintain even cold distribution.



3. Add the porcelain Gastronom platter and enjoy chilled food for at least 3 hours.



**DWFB20ICESET** ●

Set includes: 1 Plastic Tray which fits into a Riser, 2 Cooling Blocks and 2 Buffer Pouches. Gastronom Platters and Risers sold separately.

- DWFBGN1** ● Gastronom White Rectangle Platter 1/1
- DWFBGN12** ● Gastronom White Rectangle Platter 1/2
- DWFBGCBP** Buffer Pouch L 10 7/8" W 9 1/2" H 1 1/4"
- DWFBGCGN12ICE** Cooling Block L 10 1/2" W 9 7/8" H 9 7/8"
- DWFBGCGNTRAY** Tray Plastic L 20 1/2" W 12 5/8" H 1 1/4"

- Gastronom Buffet Riser
- 58.4 x 38.1 x 18.4cm H (23" x 15" x 7 1/4" H)
- DWFB20127WDT** ● Natural Teak
- DWFB20127WDAG** ● Ash Grey Teak
- DWFB20127WDGW** ● Grey Wash Teak

**NEW** D.W. HABER *ice cell*



- Low Profile Gastronom Riser
- 58.4 x 38.1 x 7.9cm (L 23" W 15" H 3 1/8")
- DWFB21132WDT** ● Natural Teak
- DWFB21132WDAG** ● Ash Grey Teak
- DWFB21132WDGW** ● Grey Wash Teak



**fusion hot buffet inserts & accessories**

Induction Range **1800** Watt  
34.3 x 31.8 x 11.4cm H  
(13½" x 12½" x 4½" H)  
1800w/220V  
**DWELIN1800BE2** ● EU PLUG  
**DWELIN1800BE3** UK PLUG  
Induction Warmer **300** Watt  
300w/220V  
**DWELIN300BE2** ● EU PLUG  
**DWELIN300BE3** UK PLUG

Black Fusion Induction Adapter Ring  
**DWFB14ADAPBK** ● 35.6cm (14")  
(Required for Induction when used with the 14" teak risers)

Power Cell Cordless Induction Range Patent-Pending **NEW**  
220V EU & UK Plug  
**DWELINPCE2E3** ● L 37.1cm x W 33.0cm (L 14½" W 13" H 3")  
Travel Case  
**DWELINPCCASE** ● **NEW**  
L 19" W 15⅞" H 7⅞"

Power Cell Cover Up **NEW**  
L 42.8 x W 38.1 x H 9.5cm (L 16⅞" W 15" H 3¾")  
**DWFB15133WDAG** ● Ash Grey Teak  
**DWFB15133WDT** ● Natural Teak  
**DWFB15133WDGW** ● Grey Wash Teak

Fusion Grill for Gastronorm Riser  
Stainless Steel  
**DWFB20GRILL** ●  
L 21¼" W 13¼"

Square Grill  
**DWFB14GRILL** ●  
35.6cm (L W 14")

Square Grill  
**DWFB11GRILL** ●  
27.9cm (L W 11")

Square Aluminium Hot Plate (Not recommended for use on Wood Risers)  
**DWFB14ALUM** ● 35.6cm (L W 14")

Fuel Shelf for Fusion Gastronorm Riser (Fuel Holders Not Included)  
**DWFB20SHELF** ● L 14½" W 4"  
Fuel Holder **DW01001** ●

**fusion ambient buffet inserts & accessories**

Bakery Split Cover  
**7345MW150** ●  
54.6cm x 34.9cm (L 21½" W 13¾")  
Fits EL590, EL591, DW08WP6PL

Hinged Acrylic Lid  
**DWFB14CVRH** ●  
35.6cm (L W 14") Clear  
Fits 14" Fusion Square Risers

**fusion cold buffet inserts & accessories**

Fusion Aluminium Square Bowl  
**DWFCAB19W** ● 48.3cm (L W 19" H 4")  
(Fits 14" Fusion Riser)  
Custom Powder Coating Available

Fusion Aluminium Square Bowl  
**DWFCAB16W** ● 40.6cm (L W 16" H 2")  
(Fits 14" Fusion Riser)  
Custom Powder Coating Available

Fusion Aluminium Divided Square Bowl  
**DWFCAB16DW** ● 40.6cm (L W 16" H 2")  
(Fits 14" Fusion Riser)  
Custom Powder Coating Available

Ice Bin for Gastronorm Risers  
**DW08WP6PL** ●  
50.8 x 30.5 x 15.2cm (L 20⅞" W 12¾" H 6")  
(Fits DWFB20127)



**additional fusion buffet inserts & accessories**

Satin Universal Cover Holder  
**DW396CVRHOLD1** ●  
27.7cm x 11.4cm (L 11" H 4½")

Satin Adapter Clip to Attach Cover Holder for Wood Fusion Risers  
**DWFB14CLIPHOLD1** ●

Attachable Utensil Holder for Wood Fusion Risers  
**DWFBREST2** ●  
24.1cm (L 9½" W 4⅝")

Attachable Utensil Holder for Metal Fusion Risers  
**DWFBREST** ●  
24.1cm (L 9½" W 4⅝")

Black Universal Shelf Holder for Teak Fusion Risers  
**DWFBUSHT4** ●  
Includes 4 pieces. Fits all teak risers and holds glass, resin or wood tiles

Stainless Steel Hanging Card Holder for Fusion Wood Risers  
**DW07373HK2SS** ●  
9.8cm (L 3⅞" W 2⅝")

Black Hanging Card Holder for Fusion Wood Risers  
**DW07373HK2BK** ●  
9.8cm (L 3⅞" W 2⅝")

Stainless Steel Hanging Card Holder for Fusion Metal Risers  
**DW07373HK2SS** ●  
9.8cm (L 3⅞" W 2⅝")

Stainless Steel Freestanding Card Holder  
**DW07372SS** ●  
9.8cm (L 3⅞" W 2⅝")

Black Freestanding Card Holder  
**DW07372BK** ●  
9.8cm (L 3⅞" W 2⅝")

D.W. HABER *storage carts*

Black powder coated storage and transport cart ideal for Fusion risers. Easy to manoeuvre with adjustable shelves.

Hammered Spoon Rest  
**DW394SRM** ●  
13.4cm (L 5¼" W 3¾" H 3")

Spoon Rest  
**DW394SR** ●  
13.4cm (L 5¼" W 3¾" H 3")

Drip Tray w/Drainer  
**DW30045SET** ●  
D 13.4cm (5¼")

Square Drip Tray w/Drainer  
**DWDRIP5QSETSS** ●  
L W 12.7cm (5")

Large Cart for Fusion Risers (Risers not included)  
**DWFCARTLGI** ●  
182.9 x 86.4 x 155.0cm (L 72" W 34" H 61")  
8" Wheels

Mini Cart for Fusion Risers (Risers not included)  
**DWFCART2** ●  
114.3 x 76.2 x 111.75cm (L 45" W 30" H 44")  
5" Wheels



*bringing foodservice displays to new heights*

D.W. Haber tiered stands are the perfect addition to buffets or food stations. With 4 and 5-level options, these stands have an elegant look and are designed with no screws or parts, so they are easy to assemble or replace & replenish glass shelves during service. The stands have the ability to showcase multiple dishes at once, so they are perfectly designed for numerous grab & go desserts, a back bar station for glassware, and more. The options are as vast as your creativity.



White Wave 4 Tier Presentation Display  
**DW412WVW** ●  
Overall dimensions with glass shelves  
101.6 x 40.6 x 64.8cm  
(L 40" W 16" H 25½")



Black Wave 4 Tier Presentation Display  
**DW412WVK** ●  
Overall dimensions with glass shelves  
101.6 x 40.6 x 64.8cm  
(L 40" W 16" H 25½")



Fusion Mini Cart  
**DWFCART2** ●  
Fits up to 4 Wave Sets  
114.3 x 76.2 x 111.75cm  
(L 45" W 30" H 44")  
Removable centre shelf (not shown) & double glass storage  
Can also fit 2 Waves in addition to Fusion Package (Risers not included)



5 Tier Presentation Display Stand w/Clear Glass  
**DW5TC** ● 91.4cm x 28.0cm x 104.1cm (L 36" W 11" H 41")  
(Some assembly required)



5 Tier Presentation Display Stand w/Black Glass  
**DW5TBK** ● 91.4cm x 28.0cm x 104.1cm (L 36" W 11" H 41")  
(Some assembly required)





Oval Faceted Acacia Board  
**6525TW321**  
71.1 x 30.5 x 5.0cm (28" x 12" x 2" h)



Square Faceted Acacia Board  
**6525TW322**  
38.1 x 38.1 x 5.0cm (15" x 15" x 2" h)

*elevate your buffet presentation*

Bring your buffet to new heights with the wood offerings from Creations Buffet. Available in various shapes and sizes, these platforms offer a unique and exciting solution for your foodservice presentation. Designed from acacia wood, the serving boards are strong, durable, and resistant to staining, while providing a look that will attract the eyes of your guests every time.

D=Diameter L=Length W=Width H=Height • All Products are Measured at Max Capacity (oz)



*wood platform  
dimensions*

- (1) Base D 14"
- (2) Platform D 10"
- (2) Platform D 8"
- (1) Platform D 6"
- Light Assembly Required



*buffet presentation reaching new heights*

Handcrafted in the USA, these beautifully unique, vertical stands are like no other! Utilising mixed mediums of industrial pipe and wood, these display stands offer height and mobility for visually pleasing presentations. Available in three distinct finishes, the pipe arms are movable and can be adjusted for a variety of display options. Great for a multitude of uses from coffee & tea service to pastries and fruit smoothies to small appetizers, you can accessorise your display stand with an unlimited variety of small plates, cups, dishes, etc. that Steelite has to offer.



- 3-Tier Stand With Pipe Legs  
35.6cm x 66.0cm (D 14" x H 26")  
Platforms:  
35.6cm (14"), 25.4cm (10"), 20.3cm (8")  
**6525T204** Ebony  
**6525T200** Chestnut  
**6525T208** Aged White
- 3-Tier Stand  
35.6cm x 52.7cm (D 14" H 20¾")  
Platforms:  
35.6cm (14"), 25.4cm (10"), 20.3cm (8")  
**6525T205** Ebony  
**6525T201** Chestnut  
**6525T209** Aged White



- Platform Stand With Pipe Legs  
35.6cm x 12.1cm (D 14" H 4¾")  
**6525T207** Ebony  
**6525T203** Chestnut  
**6525T211** Aged White
- Fits Creations Polycrystal Cloche  
**7100DR063** • (D 10" H 7")
- Platform Stand With Pipe Legs  
35.6cm x 17.1cm (D 14" H 6¾")  
**6525T206** Ebony  
**6525T202** Chestnut  
**6525T210** Aged White
- Fits Creations Polycrystal Cloche  
**7100DR063** • (D 10" H 7")



- Display Stand  
**6525T074** 35.5cm x 61.5cm H (14" x 24¼" H)  
Gun Metal Pipes  
Ebony Stain Wood

- Display Stand  
**6525T072** 35.5cm x 61.5cm H (14" x 24¼" H)  
Gun Metal Pipes  
Chestnut Stain Wood

- Display Stand  
**6525T073** 35.5cm x 61.5cm H (14" x 24¼" H)  
White Pipes  
Weathered White Wood



**high quality design & durability**

Introducing Roselli Resin Risers, these round & square raised vessels not only provide functionality but durability as well. Made of commercial grade resin, these one-piece risers are resistant to stains, are dishwasher safe, and will not warp over time. A great addition to any buffet presentation, these versatile risers are designed for both hot & cold foods and are available in Smoked Paprika & Basalt colours.



Large Pedestal Bowl Stand  
Smoked Paprika  
**7700ER001** ●  
D 16" H 10¾"  
**7700ER002** ●  
D 11¼" H 8½"

Flat Round Stand w/Coupe Edge  
Smoked Paprika  
**7700ER003** ●  
L W 17½" H 9½"

Flat Square Stand w/Coupe Edge  
Smoked Paprika  
**7700ER004** ●  
L W 12¾" H 7"

Large Pedestal Bowl Stand  
Basalt  
**7710ER001** ●  
D 16" H 10¾"  
**7710ER002** ●  
D 11¼" H 8½"

Flat Round Stand w/Coupe Edge  
Basalt  
**7710ER003** ●  
L W 17½" H 9½"

Flat Square Stand w/Coupe Edge  
Basalt  
**7710ER004** ●  
L W 12¾" H 7"

D=Diameter L=Length W=Width H=Height • All Products are Measured at Max Capacity (oz)

● Non-Stock



*modern design with form & function in mind*

Ultra-modern risers by Roselli Design will take your buffet and tabletop presentation to new heights. Available in a bright white porcelain, each riser will elevate both sweet and savoury culinary presentations.



Coupe  
**6950E702** Small  
24.0cm w x 11.5cm h (9½" w x 4½" h)

Round  
**6950E706** Large  
37.0cm w x 20.25cm h (14½" w x 8" h)  
**6950E707** Medium  
29.0cm w x 16.5cm h (11½" w x 6½" h)  
Fits Creations Polycrystal Cloche  
7100DR063 • D 10" H 7"  
**6950E708** Small  
24.0cm w x 11.5cm h (9½" w x 4½" h)

Square  
**6950E703** Large  
37.0cm w x 20.25cm h (14½" w x 8" h)  
**6950E704** Medium  
29.0cm w x 16.5cm h (11½" w x 6½" h)  
**6950E705** Small  
24.0cm w x 11.5cm h (9½" w x 4½" h)



*unique resin designs for the table & beyond*

From the table to the guest room, Kenny Mack Designs handmade resin risers sit beautifully in diverse hospitality settings. Elevate your aesthetic with functional form and designs of Kenny Mack resin.

*carved risers*

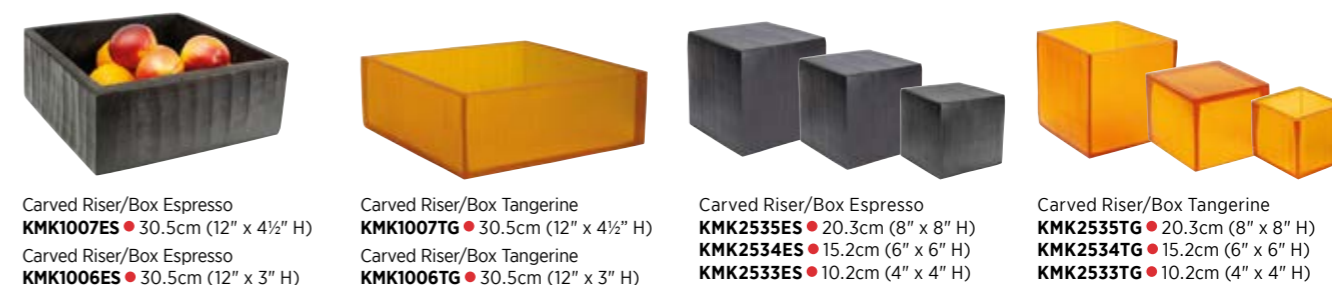

Carved Riser/Box Espresso  
**KMK1007ES** • 30.5cm (12" x 4½" H)  
Carved Riser/Box Espresso  
**KMK1006ES** • 30.5cm (12" x 3" H)

Carved Riser/Box Tangerine  
**KMK1007TG** • 30.5cm (12" x 4½" H)  
Carved Riser/Box Tangerine  
**KMK1006TG** • 30.5cm (12" x 3" H)

Carved Riser/Box Espresso  
**KMK2535ES** • 20.3cm (8" x 8" H)  
**KMK2534ES** • 15.2cm (6" x 6" H)  
**KMK2533ES** • 10.2cm (4" x 4" H)

Carved Riser/Box Tangerine  
**KMK2535TG** • 20.3cm (8" x 8" H)  
**KMK2534TG** • 15.2cm (6" x 6" H)  
**KMK2533TG** • 10.2cm (4" x 4" H)

*smooth risers*



Smooth Riser/Box Shell  
**KMK1006SH** • 30.5cm (12" x 3" H)

Smooth Riser/Box Shell  
**KMK1007SH** • 30.5cm (12" x 4½" H)

Smooth Riser/Box Shell  
**KMK2534SH** • 15.2cm (6" x 5" H)

Smooth Riser/Box Shell  
**KMK2533SH** • 10.2cm (4" x 4" H)



## Platters & Bowls

With a range of options available including square & rectangle plates, large bowls, sharing platters and gastronorm trays, Steelite International offers a number of serving vessels which are perfectly suited for patio dining, banquets and buffet dining. Each collection offers a unique style that can inspire and elevate your plating, helping you to create show stopping food presentations.



**6959E6135** ●  
Platter Rectangle  
L 18½" W 10½" H 1¼"



**6959E6134** ●  
Platter Rectangle  
L 14½" W 9½" H 1"



**6959E6136** ●  
Platter Round  
D 14"



**6959E6132** ●  
Serving Bowl  
D 15" H 4" (5qt)



**6959E6131** ●  
Serving Bowl  
D 13" H 4" (3¾qt)



**6959E6130** ●  
Serving Bowl  
D 10" H 4" (2½qt)



**6959E6133** ●  
Crock  
D 6" H 7" (2qt)



**6959E6137** ●  
Crock  
D 5" H 5½" (1qt)

D=Diameter L=Length W=Width H=Height • All Products are Measured at Max Capacity (oz)

● Non-Stock

*a buffet presentation that pops*

Introducing Alpha-Ceram Buffet, a collection of service items made of fortified porcelain that provide an eye-catching display through dimension & visual appeal. With subtle embossments and a full indigo glaze, these serving vessels are shaped with accentuated curves and bring an added softness to the display. Made of a lightweight, yet durable material, service is easy and clean up is quick & efficient.



*slate*



Gastronorm Platter  
**7184TM049A** ● 1/1  
53.0cm x 32.7cm (21" x 12¾" H 1")  
**7184TM048A** ● 2/4  
53.0cm x 16.5cm (21" x 6⅜" H 1")

**7184TM047A** ● 1/2  
32.4cm x 27.0cm (12¾" x 10½" H 1")  
**7184TM046A** ● 1/3  
32.4cm x 17.5cm (12¾" x 7" H 1")

Large Round Shallow Bowl  
**7184TM043A** ●  
35.9cm x 6.7cm (14⅓" x 2⅔")  
4.5Ltr (4¾qts)

Medium Round Shallow Bowl  
**7184TM041A** ●  
29.8cm x 6.7cm (11¾" x 2⅔")  
2.5Ltr (2⅔qts)



Large Round Bowl  
**7184TM045A** ●  
41.3cm x 17.5cm (16¼" x 6⅘") 15.3Ltr (16⅓qts)  
**7184TM044A** ●  
35.6 x 14.9cm (14" x 5⅞") 9.1Ltr (9⅝qts)

Medium Round Bowl  
**7184TM042A** ●  
28.6cm x 11.7cm (11¼" x 4⅔")  
4.5Ltr (4¾qts)

Small Round Bowl  
**7184TM040A** ●  
24.4cm x 9.5cm (9⅝" x 3¾")  
2.25Ltr (2⅔qts)

*stone*



Gastronorm Platter  
**7194TM049A** ● 1/1  
53.0cm x 32.7cm (21" x 12¾" H 1")  
**7194TM048A** ● 2/4  
53.0cm x 16.5cm (21" x 6⅜" H 1")

**7194TM047A** ● 1/2  
32.4cm x 27.0cm (12¾" x 10½" H 1")  
**7194TM046A** ● 1/3  
32.4cm x 17.5cm (12¾" x 7" H 1")

Large Round Shallow Bowl  
**7194TM043A** ●  
35.9cm x 6.7cm (14⅓" x 2⅔")  
4.5Ltr (4¾qts)

Medium Round Shallow Bowl  
**7194TM041A** ●  
29.8cm x 6.7cm (11¾" x 2⅔")  
2.5Ltr (2⅔qts)



Large Round Bowl  
**7184TM045A** ●  
41.3cm x 17.5cm (16¼" x 6⅘") 15.3Ltr (16⅓qts)  
**7184TM044A** ●  
35.6 x 14.9cm (14" x 5⅞") 9.1Ltr (9⅝qts)

Medium Round Bowl  
**7184TM042A** ●  
28.6cm x 11.7cm (11¼" x 4⅔")  
4.5Ltr (4¾qts)

Small Round Bowl  
**7184TM040A** ●  
24.4cm x 9.5cm (9⅝" x 3¾")  
2.25Ltr (2⅔qts)

*light weight, high durability*

Creations Pompeii Buffet generates an astonishing and memorable display. Designed for both hot and cold, this melamine collection provides high-quality design with versatility among foodservice presentations. Available in slate and stone colours, Pompeii Buffet is dishwasher safe and its break resistant structure eliminates the need to sacrifice visual quality for durability.



**stylish, versatile buffet presentation**

Add that something extra to your buffet presentation with the Gastronorm Trays by Creations. Available in a variety of sizes with corresponding covers, these large display platters come in four finishes to suite any occasion including slate, white, spiral, craft and driftwood. Offering style and versatility, the Gastronorm Trays are great for an array of foods while providing a stunning presentation every time.



Cover 1/1  
**6470ML10**  
536 x 331 x 91.5mm (21" x 13" x 3½")  
Fits EL590, EL591

Cover 1/2  
**6470ML11**  
331 x 271 x 91.5mm (13" x 10½" x 3½")  
Fits EL596, EL597

Cover 1/3  
**6470ML12**  
331 x 182 x 91.5mm (13" x 7⅞" x 3½")  
Fits EL592

Cover 2/4  
**6470ML13**  
536 x 168 x 91.5mm (21" x 6⅝" x 3½")  
Fits EL594, EL595



*slate*

Pompeii Gastronorm Platter **NEW**  
**7184TM049A** ● 1/1  
53.0cm x 32.7cm (21" x 12¾" H 1")  
**7184TM048A** ● 2/4  
53.0cm x 16.5cm (21" x 6⅝" H 1")

**7184TM047A** ● 1/2  
32.4cm x 27.0cm (12¾" x 10½" H 1")  
**7184TM046A** ● 1/3  
32.4cm x 17.5cm (12¾" x 7" H 1")



*stone*

Pompeii Gastronorm Platter **NEW**  
**7194TM049A** ● 1/1  
53.0cm x 32.7cm (21" x 12¾" H 1")  
**7194TM048A** ● 2/4  
53.0cm x 16.5cm (21" x 6⅝" H 1")

**7194TM047A** ● 1/2  
32.4cm x 27.0cm (12¾" x 10½" H 1")  
**7194TM046A** ● 1/3  
32.4cm x 17.5cm (12¾" x 7" H 1")



Driftwood Rectangle Platter 1/1  
**68A351EL590** ● 1/1  
530mm x 325mm (21" x 12¾")  
**68A351EL596** ● 2/4  
530mm x 162mm (21" x 6⅝")

Driftwood Rectangle Platter  
**68A351EL592** ● 1/2  
325mm x 265mm (12¾" x 10½")  
**68A351EL594** ● 1/3  
325mm x 176mm (12¾" x 7")



Slate Rectangle Platter  
**68A415EL591** ● 1/1  
530mm x 325mm (21" x 12¾")  
**68A415EL597** ● 2/4  
530mm x 162mm (21" x 6⅝")

Slate Rectangle Platter  
**68A415EL593** ● 1/2  
325mm x 265mm (12¾" x 10½")  
**68A415EL595** ● 1/3  
325mm x 176mm (12¾" x 7")



Craft White Rectangle Platter 1/1  
**68A416EL591** ● 1/1  
530mm x 325mm (21" x 12¾")  
**68A416EL597** ● 2/4  
530mm x 162mm (21" x 6⅝")

Craft White Rectangle Platter  
**68A416EL593** ● 1/2  
325mm x 265mm (12¾" x 10½")  
**68A416EL595** ● 1/3  
325mm x 176mm (12¾" x 7")





*craft melamine extends to buffet service*

Give your buffet an upgrade with these large melamine serving pieces from Creations. Designed to replicate our ever-popular Craft dinnerware collection, this melamine offering is made to withstand the rigours of foodservice and is dishwasher safe. Craft melamine has a neutral colour palette that blends well with existing service items, providing the opportunity for a customer to create a personalised and on-trend presentation.



Extra Large Round Bowl  
**68A632EL863** ●  
38.1cm x 15.2cm H (15" x 6" H)  
11.8Ltr (12½qts)



Large Round Bowl  
**68A632EL862** ●  
33.0cm x 12.7cm H (13" x 5" H)  
7.6Ltr (8qts)



Medium Round Bowl  
**68A632EL861** ●  
27.9cm x 10.2cm H (11" x 4" H)  
3.8Ltr (4qts)



Small Round Bowl  
**68A632EL864** ●  
22.9cm x 7.6cm H (9" x 3" H)  
2.1Ltr (2¼qts)



Square Pebble Bowl  
**68A632EL866**  
38.1cm x 8.3cm H (15" x 3¼" H)  
4.7Ltr (5qts)



Square Pebble Bowl  
**68A632EL865** ●  
34.3cm x 7.6cm H (13½" x 3" H)  
2.8Ltr (3qts)



Square Pebble Bowl  
**68A632EL867**  
25.4cm x 3.8cm H (10" x 1½" H)  
0.9Ltr (1qts)



Medium Round Platter  
**68A632EL860** ●  
33.0cm x 5.1cm H (13" x 2" H)  
3.3Ltr (3½qts)

D=Diameter L=Length W=Width H=Height • All Products are Measured at Max Capacity (oz)

● Stocked in European Warehouse



**long-lasting & robust**

Reminiscent of a deep blue sky and rocky mountain hillside is the Quarry collection by Creations Melamine. These hearty platters and bowls feature a unique, stone-like decal on a highly durable melamine body and are ideally sized to meet the needs of any buffet presentation.



Bowl  
**7192TM302A** ●  
37.5 x 32.1 x 9.2cm (14¾" x 12⅝" x 3⅝")  
520.5cl (5½ qts)



Bowl  
**7192TM301A** ●  
43.2 x 24.1 x 7.6cm (17" x 9½" x 3")  
260.2cl (2¾ qts)



Square Bowl  
**7192TM300A** ●  
26.03 x 24.8 x 7.6cm (10¼" x 9¾" x 3")  
189cl (2 qts)



V Shape Bowl  
**7192TM303A** ●  
25.1 x 25.1 x 15.6cm (9⅞" x 9⅞" x 6⅞")  
402.2cl (4¼ qts)



Platter  
**7192TM304A** ●  
45.7 x 22.9 x 3.8cm (18" x 9" x 1½")

D=Diameter L=Length W=Width H=Height • All Products are Measured at Max Capacity (oz)

● Stocked in European Warehouse



Plate  
**68A451EL707** ●  
28.0cm Dia (11")



Plate  
**68A451EL706** ●  
23.0cm Dia (9")



Plate  
**68A451EL705** ●  
16.5cm Dia (6½")



Large Oval Platter  
**68A451EL703** ●  
40.0cm x 24.2cm (16" x 9½")



Medium Deep Bowl  
**68A451EL704** ●  
18.0cm x 7.8cm H (7" x 3")  
40.0cl (13½oz)



Small Deep Bowl  
**68A451EL708** ●  
13.0cm x 5.3cm H (5" x 2")  
15.0cl (5oz)

*natural, subtle textures*

Inspired by the living elements of a natural landscape, Scape portrays subtle textures and colours that are organically created in nature. Scape offers a free-flowing design with a multi-material approach to transition from casual to formal dining styles and enhances buffet presentations. Available in high alumina vitrified china, melamine, and glass, Scape offers exceptional style, durability, and grace while delivering a genuinely innovative experience.



Cameron Bowl  
Shell  
**KMK1037SH** ●  
33.0cm (D 13" H 4") (4½qt)



Cameron Bowl  
Tortoise  
**KMK1037TOR** ●  
33.0cm (D 13" H 4") (4½qt)



Cameron Bowl  
Tangerine Pearl  
**KMK1037TGP** ●  
33.0cm (D 13" H 4") (4½qt)

***unique resin for tabletop & buffet***

Kenny Mack Designs features a durable & break resistant resin that is ideal for commercial foodservice. With a multitude of shapes, colours, and sizes, this collection combines functional form and reliability. Inclusive of serving bowls, platters, trays, risers, and more, Kenny Mack resin will elevate any buffet presentation.



Wave Wide Oval Platter  
Tortoise  
**KMK2717TOR** ●  
61.0cm (L 24" W 14" H 1½")

Wave Rectangle Platter  
Tortoise  
**KMK2805TOR** ●  
L 21¼" W 9½" H 2½"

Wave Round Bowl  
Tortoise  
**KMK2720TOR** ●  
45.7cm (D 18" H 5") 2¼gal  
**KMK2718TOR** ●  
33.0cm (D 13" H 4") 3¼qt

Wave Shallow Oval Bowl  
Tortoise  
**KMK2721TOR** ●  
L 19" W 15" H 4"  
1 gal

Wave Condiment Bowl  
Tortoise  
**KMK1028TOR** ●  
12.1cm (D 4¾" H 2¾")  
23.7cl (8oz)



Wave Rectangle Platter  
Tangerine Pearl  
**KMK2805TGP** ●  
L 21¼" W 9½" H 2½"

Wave Round Bowl  
Tangerine Pearl  
**KMK2718TGP** ● 33.0cm (D 13" H 4") 3¼qt  
Wave Shallow Oval Bowl  
**KMK2721TGP** ● L 19" W 15" H 4" (1gal)

Wave Rectangle Bowl  
Tangerine Pearl  
**KMK2016TGP** ●  
24.1cm (L 19½" W 10" H 2¼")  
3¼qt

Wave Crock  
Tangerine Pearl  
**KMK2934TGP** ●  
14.0cm (L 5½" H 6½")  
94.6cl (32oz)

Wave Condiment Bowl  
Tangerine Pearl  
**KMK1028TGP** ●  
12.1cm (D 4¾" H 2¾")  
23.7cl (8oz)



Wave Oval Bowl  
Marine Blue Pearl  
**KMK2021MBP** ●  
48.3cm (L 19" W 11½" H 8")  
(2gal)

Wave Crock  
Marine Blue Pearl  
**KMK2934MBP** ●  
14.0cm (L 5½" H 6½")  
94.6cl (32oz)

Wave Condiment Bowl  
Marine Blue Pearl  
**KMK1028MBP** ●  
12.1cm (D 4¾" H 2¾")  
23.7cl (8oz)

Wave Oval Tray  
Ebony Pearl  
**KMK2158EBP** ●  
45.7cm (L 18" W 9¾" H 1¼")

Wave Crock  
Ebony Pearl  
**KMK2934EBP** ●  
14.0cm (L 5½" H 6½")  
94.6cl (32oz)

Wave Condiment Bowl  
Ebony Pearl  
**KMK1028EBP** ●  
12.1cm (D 4¾" H 2¾")  
23.7cl (8oz)



Wave Trough Centerpiece  
Grey Ice  
**KMK2733GICE** ● 91.4cm (L 36" W 6" H 4") (1½gal)  
**KMK2732GICE** ● 55.9cm (L 22" W 6" H 4") (3¼qt)

Wave Round Bowl  
Grey Ice  
**KMK2720GICE** ●  
45.7cm (D 18" H 5") (2¼gal)

Wave Round Bowl  
Grey Ice  
**KMK2718GICE** ●  
33.0cm (D 13" H 4") (3¼qt)



Wave Round Platter  
Shell  
**KMK2716SH** ●  
50.8cm (D 20" H 2")

Wave Round Platter  
Shell  
**KMK2165SH** ●  
35.6cm (D 14" H 1½")

Wide Oval Platter  
Shell  
**KMK2717SH** ●  
61.0cm (L 24" W 14" H 1½")



Wave Oval Tray  
Shell  
**KMK2141SH** ● 61.0cm (L 24" W 12" H 1¼")  
**KMK2158SH** ● 45.7cm (L 18" W 9¾" H 1¼")

Wave Rectangle Platter  
Shell  
**KMK2805SH** ●  
L 21¼" W 9½" H 2½"

Wave Oval Bowl  
Shell  
**KMK2021SH** ●  
48.3cm (L 19" W 11½" H 8")



Wave Round Bowl  
Shell  
**KMK2720SH** ●  
45.7cm (D 18" H 5") (2¼gal)  
**KMK2718SH** ● 33.0cm (D 13" H 4")

Wave Shallow Oval Bowl  
Shell  
**KMK2721SH** ●  
L 19" W 15" H 4" (1 gal)

Wave Rectangle Bowl  
Shell  
**KMK2016SH** ●  
24.1cm (L 19½" W 10" H 2¼")  
(3¼qt)

Wave Square Bowl  
Shell  
**KMK1044SH** ●  
35.6cm (L W 14" H 3½")  
(4¼qt)



Wave Square Bowl  
Shell  
**KMK1043SH** ●  
27.9cm (L W 11" H 3")  
(2¼qt)

Wave Rectangle Bowl  
Shell  
**KMK2015SH** ●  
27.9cm (L 11" W 7½" H 2½")  
(1qt)

Wave Square Bowl  
Shell  
**KMK1030SH** ●  
17.8cm (L W 7" H 2¼")  
(25½oz)

Wave Crock  
Shell  
**KMK2934SH** ●  
14.0cm (L 5½" H 6½")  
94.6cl (32oz)

Wave Condiment Bowl  
Shell  
**KMK1028SH** ●  
12.1cm (D 4¾" H 2¾")  
23.7cl (8oz)



Wave Trough Centerpiece  
Shell  
**KMK2733SH** ●  
91.4cm (L 36" W 6" H 4") (1½gal)

Wave Trough Centerpiece  
Shell  
**KMK2732SH** ●  
55.9cm (L 22" W 6" H 4") (3¼qt)



Jagged Edge Tray  
Espresso  
**KMK2170ES** ●  
45.7cm (D 18" H 1/2")



Jagged Edge Tray  
Espresso  
**KMK2150ES** ●  
36.8cm (D 14 1/2" H 1/2")



Oval Bark Bowl  
Espresso  
**KMK2059ES** ●  
45.7cm (L 18" W 14" H 6 1/2")  
(1 1/4gal)



Oval Bark Bowl  
Espresso  
**KMK2082ES** ●  
33.0cm (L 13" W 10" H 4")  
(1 1/2qt)



Royal Palm Bark Tray  
Espresso  
**KMK2058ES** ●  
48.3cm (L 19" W 5" H 2")



Curved Palm Leaf Tray  
Shell  
**KMK2052SH** ●  
43.2cm (L 17" W 6 1/2" H 3")



Curved Palm Leaf Tray  
Espresso  
**KMK2052ES** ●  
43.2cm (L 17" W 6 1/2" H 3")



Jagged Edge Bowl  
Espresso  
**KMK2083ES** ●  
33.0cm (D 13" H 4 1/2")  
(1gal)



Jagged Edge Bowl  
Espresso  
**KMK2084ES** ●  
26.7cm (D 10 1/2" H 4")  
(2qt)



Oval Bark Bowl  
Espresso  
**KMK2081ES** ●  
25.4cm (L 10" W 8" H 3 1/4")  
(1qt)



Jagged Edge Bowl  
Espresso  
**KMK2070ES** ●  
18.4cm (D 7 1/4" H 3")  
(23oz)



Curved Footed Tray  
Espresso  
**KMK2109ES** ●  
45.7cm (L 18" W 5" H 1 1/4")



Curved Footed Tray  
Espresso  
**KMK2108ES** ●  
38.1cm (L 15" W 4 1/2" H 1 1/2")



Curved Footed Tray  
Espresso  
**KMK2107ES** ●  
30.5cm (L 12" W 4" H 1 1/4")



Jagged Edge Tray  
Shell  
**KMK2170SH** ●  
45.7cm (D 18" H 1/2")



Jagged Edge Tray  
Shell  
**KMK2150SH** ●  
36.8cm (D 14 1/2" H 1/2")



Oval Bark Bowl  
Shell  
**KMK2059SH** ●  
45.7cm (L 18" W 14" H 6 1/2")  
(1 1/4gal)



Oval Bark Bowl  
Shell  
**KMK2082SH** ●  
33.0cm (L 13" W 10" H 4")  
(1 1/2qt)



Square Charger Tray  
Shell  
**KMK1034SH** ●  
38.1cm (L W 15" H 1 1/2")



Square Charger Tray  
Shell  
**KMK2139SH** ●  
33.0cm (L W 13" H 1 1/2")



Square Charger Tray  
Shell Marine Blue Pearl  
**KMK2136SHMBP** ●  
33.0cm (L W 13" H 1 1/2")

*charger*



Jagged Edge Bowl  
Shell  
**KMK2083SH** ●  
33.0cm (D 13" H 4 1/2")  
(1gal)



Jagged Edge Bowl  
Shell  
**KMK2084SH** ●  
26.7cm (D 10 1/2" H 4")  
(2qt)



Oval Bark Bowl  
Shell  
**KMK2081SH** ●  
25.4cm (L 10" W 8" H 3 1/4")  
(1qt)



Jagged Edge Bowl  
Shell  
**KMK2070SH** ●  
18.4cm (D 7 1/4" H 3")  
(23oz)



Gallery Rectangle Tray  
Shell  
**KMK2145SH** ●  
59.7cm (L 23 1/2" W 4" H 1")

*gallery*



Ripple Oval Tray  
Shell Marine Blue Pearl  
**KMK2139SHMBP** ●  
33.0cm (L 13" W 4 1/2" H 1 1/2")



Ripple Rectangle Tray  
Shell Marine Blue Pearl  
**KMK2136SHMBP** ●  
30.5cm (L 12" W 9" H 7")

*ripple*





Fusion Square Tray  
Shell  
**KMK2800SH** ●  
L W 12 1/8" H 1 1/4"



Fusion Square Bowl  
Shell  
**KMK2801SH**  
31.1cm (L W 12 1/4" H 4 3/4")  
(1 1/4gal)



Fusion Square Bowl  
Shell  
**KMK2802SH**  
26.7cm (L W 10 1/2" H 4 1/4")  
(3/4qt)



Fusion Square Bowl  
Shell  
**KMK2803SH**  
20.3cm (L W 8" H 3 1/2")  
(1 1/2qt)



Fusion Square Bowl  
Shell  
**KMK2806SH**  
15.2cm (L W 6" H 2 3/4")  
(19oz)



Fusion Square Tray  
Tangerine Pearl  
**KMK2800TGP** ●  
L W 12 1/8" H 1 1/4"



Fusion Square Bowl  
Tangerine Pearl  
**KMK2801TGP**  
31.1cm (L W 12 1/4" H 4 3/4")  
(1 1/4gal)



Fusion Square Bowl  
Tangerine Pearl  
**KMK2802TGP**  
26.7cm (L W 10 1/2" H 4 1/4")  
(3/4qt)



Fusion Square Bowl  
Tangerine Pearl  
**KMK2803TGP**  
20.3cm (L W 8" H 3 1/2")  
(1 1/2qt)



Fusion Square Bowl  
Tangerine Pearl  
**KMK2806TGP**  
15.2cm (L W 6" H 2 3/4")  
(19oz)



Fusion Square Tray  
Tortoise  
**KMK2800TOR** ●  
L W 12 1/8" H 1 1/4"



Fusion Square Bowl  
Tortoise  
**KMK2801TOR**  
31.1cm (L W 12 1/4" H 4 3/4")  
(1 1/4gal)



Fusion Square Bowl  
Tortoise  
**KMK2802TOR**  
26.7cm (L W 10 1/2" H 4 1/4")  
(3/4qt)



Fusion Square Bowl  
Tortoise  
**KMK2803TOR**  
20.3cm (L W 8" H 3 1/2")  
(1 1/2qt)



Fusion Square Bowl  
Tortoise  
**KMK2806TOR**  
15.2cm (L W 6" H 2 3/4")  
(19oz)

*slant*



Slant Bowl  
Tortoise  
**KMK1025TOR** ●  
20.3cm (D 8" H 6")  
(1qt)  
**KMK1024TOR** ●  
16.5cm (D 6 1/2" H 4")  
(16oz)



Slant Bowl  
Tangerine Pearl  
**KMK1025TGP** ●  
20.3cm (D 8" H 6")  
(1qt)  
**KMK1024TGP** ●  
16.5cm (D 6 1/2" H 4")  
(16oz)



Slant Bowl  
Shell  
**KMK1025SH** ●  
20.3cm (D 8" H 6")  
(1qt)  
**KMK1024SH** ●  
16.5cm (D 6 1/2" H 4")  
(16oz)



Slant Bowl  
Ebony Pearl  
**KMK1025EBP** ●  
20.3cm (D 8" H 6")  
(1qt)  
**KMK1024EBP** ●  
16.5cm (D 6 1/2" H 4")  
(16oz)



Circle Bowl  
Tortoise  
**KMK2086TOR** ●  
50.8cm (D 20" H 6") (7 1/4gal)



Circle Bowl  
Tortoise  
**KMK2000TOR** ●  
40.6cm (D 16" H 5") (2 3/4gal)



Circle Bowl  
Tortoise  
**KMK2001TOR** ●  
34.3cm (D 13 1/2" H 4 1/2") (1 1/4gal)



Circle Bowl  
Tortoise  
**KMK2003TOR** ●  
25.4cm (D 10" H 4") (3 1/2qt)



Circle Bowl  
Shell  
**KMK2086SH** ●  
50.8cm (D 20" H 6") (7 1/4gal)



Circle Bowl  
Shell  
**KMK2000SH** ●  
40.6cm (D 16" H 5") (2 3/4gal)



Circle Bowl  
Shell  
**KMK2001SH** ●  
34.3cm (D 13 1/2" H 4 1/2") (1 1/4gal)



Circle Bowl  
Shell  
**KMK2003SH** ●  
25.4cm (D 10" H 4") (3 1/2qt)



Point Bowl  
Espresso  
**KMK2025ES** ●  
54.6cm (L 21 1/2" W 8" H 4")  
(3qt)



Point Bowl  
Espresso  
**KMK2024ES** ●  
33.0cm (L 13" W 6 1/2" H 3 1/2")  
(1 1/4qt)



Point Bowl  
Espresso  
**KMK2023ES** ●  
27.9cm (L 11" W 5 1/2" H 2 3/4")  
(25oz)



Point Bowl  
Espresso  
**KMK2022ES** ●  
24.1cm (L 9 1/2" W 4 1/2" H 2")  
(10oz)



Point Bowl  
Shell  
**KMK2025SH** ●  
54.6cm (L 21 1/2" W 8" H 4")  
(3qt)



Point Bowl  
Shell  
**KMK2024SH** ●  
33.0cm (L 13" W 6 1/2" H 3 1/2")  
(1 1/4qt)



Point Bowl  
Shell  
**KMK2023SH** ●  
27.9cm (L 11" W 5 1/2" H 2 3/4")  
(25oz)



Point Bowl  
Shell  
**KMK2022SH** ●  
24.1cm (L 9 1/2" W 4 1/2" H 2")  
(10oz)

*point*



Scoop Bowl  
Ebony Pearl  
**KMK1019EBP**  
34.3cm (D 13 1/2" H 6")  
(2gal)



Scoop Bowl  
Ebony Pearl  
**KMK1018EBP**  
24.1cm (D 9 1/2" H 5")  
(3qt)



Scoop Bowl  
Tangerine Pearl  
**KMK1019TGP**  
34.3cm (D 13 1/2" H 6")  
(2gal)



Scoop Bowl  
Tangerine Pearl  
**KMK1018TGP**  
24.1cm (D 9 1/2" H 5")  
(3qt)



Scoop Bowl  
Shell  
**KMK1019SH**  
34.3cm (D 13 1/2" H 6")  
(2gal)



Scoop Bowl  
Shell  
**KMK1018SH**  
24.1cm (D 9 1/2" H 5") (3qt)

*scoop*

*avocado trio bowls*



Avocado Trio Bowl  
Espresso  
**KMK2067ES** ●  
20.3cm (W 8" H 2 1/2")  
(7oz each)



Avocado Trio Bowl  
Shell  
**KMK2067SH** ●  
20.3cm (W 8" H 2 1/2")  
(7oz each)



## Hollowware & Metal Accessories

Whether it's coffee or water service, canapés or tea sandwiches, your tabletop deserves quality stainless steel hollowware from Steelite International. Our collections perfectly pair with any existing items, and offer a variety of accessory pieces to ensure your table & room service are complete.





Wine/Champagne Bucket Stand  
**5977RW003**  
D 28.0cm H 64.0cm  
(D 11" H 25¼")



Wine/Champagne Cooler Large  
**5977RW020**  
L 10½" W 16⅞" H 16⅞"



Condiment Servers Set  
**5977RW006**  
7.5 x 9.0 x 9.5cm H



Pinch Pot Set w/ Walnut Base  
**5977RW008**  
7.0 x 14.0 x 4.0cm H



Double Wine/Champagne Bucket  
**5977RW002**  
L 28.0cm W 21.5cm H 23.0cm  
(L 11" W 8½" H 9")  
Single Wine/Champagne Bucket  
**5977RW001**  
L 23.5cm W 19.0cm H 21.0cm  
(L 8⅞" W 7½" H 8⅞")



Double Walled Wine/Champagne Cooler  
**5977RW013**  
L 13.6cm W 13.4cm H 22.4cm  
(L 5⅜" W 5¼" H 9")



Jug w/Ice Guard  
**5977RW017**  
L 8⅞" W 6⅞" H 5½"  
2L (2¼qt)



Coffee Server  
**5977RW107** 2L (2¼qt)



Jug  
**5977RW016** 300ml (10oz)  
**5977RW015** 150ml (5oz)



Cake Stand  
**5977RW014**  
L 24.2cm W 24.2cm H 42.0cm  
(D 9½" H 16½")



Two Tier Canapé Stand  
**5977RW106**  
H 21.4cm  
(L 4⅞" W 4⅞" H 4⅞")

*beautifully designed, quality made*

With a tiered cake stand and three accompanied trays, wine chillers and jugs, the Drift collection offers a range of elegant presentation pieces for your tabletop or buffet. Designed to be both aesthetically unique and highly functional, all Drift items are made from 18/10 stainless steel.

D=Diameter L=Length W=Width H=Height • All Products are Measured at Max Capacity (oz)



*stainless steel hollowware*

Traditional hollowware is named after its design and style, offering an elegant, yet classic method of coffee and tea service. The solid bar hinges and dripless spouts add that extra appeal for tableside service.



*simply designed & durable*

Offering insulated coffee, water and tea pots, Tower hollowware is sure to keep your beverage at the right temperature. With solid bar hinges and dripless spouts, Tower is your go-to choice for hollowware.



*tear drop*

*artisanal texture*

Reduce the appearance of fingerprints with Tear Drop Hammered Hollowware by D.W. Haber. Comprised of 18/10 stainless steel, the spout and opening resemble a teardrop while the finish is lightly hammered, creating a unique presentation for your tabletop.



D=Diameter L=Length W=Width H=Height • All Products are Measured at Max Capacity (oz)

• Non-Stock



*unlimited buffet additions*

Complement your foodservice display with a wide selection of buffet accessories. Stainless steel spoon rests, sauce boats, trays and more make up this collection by D.W. Haber.



Round Modern Tray  
**DW1414P** ● D 35.6cm (14")



Bread Tray w/Applied Border  
**DW1612** ● L 30.5cm (12")  
**DW1609** ● L 22.9cm (9")



Tempo Bread Tray  
**DW1709** ● 25.4cm (L 10" W 5½" H 3½")



Ogee Cash Tray  
**DW3509** ● 22.9cm x 15.2cm (L 9" W 6")



Rectangle Serving Dish  
**DW071794SS** ● 22.9cm x 11.4cm (L 9" W 4½" H 1½")



Sugar Packet Holder  
**DW02113SS** ● 6.4cm x 4.5cm (L 2½" W 1¾" H 2")



Modern Number Stand  
**DW04181MSS** ● 45.7cm H (L 4" W 4" H 18")  
**DW04121MSS** ● 30.5cm H (L 4" W 4" H 12")



3 Compartment SS Condiment Server Bowls  
**DW3913** ● 16.5cm (L 6½" W 6½" H 6½")



Caviar Set  
**DW04955SS** ● 5 Bowls w/Top Ring (W 8" H 6")



Supreme 3 Piece Set w/Base  
**DW1001B3** ● (L 5½" W 5½" H 3½")



2 Piece Silver Plate Tea Strainer w/Cup  
**DW0497** ●



Ladle Rest  
**DW396LADREST** ● 15.2cm (L 6" W 5¼" H 8¾")



Stackable Sauceboat  
**DW8011SS** ● 24.1cm (L 9½" W 4" H 3¾") 32.5cl (11oz)  
**DW8008SS** ● (L 8¾" W 4¾" H 2¾") (8oz)  
**DW8005SS** ● (L 7½" W 3¾" H 2½") (5oz)



Coaster/Underliner  
**DW30044** ● D 13.4cm (5¼") 7.6cm (3") Well



Coaster/Underliner  
**DW30045** ● D 13.4cm (5¼") 10.2cm (4") Well



Flatware Caddy w/Centre for Cocktail Napkins or Knives  
**DW0738SS** ● 27.9cm (L 11" W 9" H 5")



Satin Universal Cover Holder  
**DW396CVRHOLD1** ● 27.7cm x 11.4cm (L 11" H 4½")



Satin Adapter Clip to Attach Cover Holder for Wood Fusion Risers  
**DWFB14CLIPHOLD1** ●



Replacement Fuel Holder  
**DW01001** ● (L 6¾" W¾" H 3")



Hammered Spoon Rest  
**DW394SRM** ● 13.4cm (L 5¼" W 3¾" H 3")



Spoon Rest  
**DW394SR** ● 13.4cm (L 5¼" W 3¾" H 3")



Engraved ID Tents Mirror Stainless Steel  
**DWIDENTCSS** ● Coffee L 3¾" W 2¼"  
**DWIDENTDSS** ● Decaf L 3¾" W 2¼"  
**DWIDENTHSS** ● Hot Water L 3¾" W 2¼"  
**DWIDENTXSS** ● Blank L 3¾" W 2¼"

Unlimited options for engraving (ex. Tea, Cream, Milk, etc.)



Stainless Steel Freestanding Card Holder  
**DW07372SS** ● 9.8cm (L 3⅞" W 2⅝")



Black Freestanding Card Holder  
**DW07372BK** ● 9.8cm (L 3⅞" W 2⅝")



Drip Tray w/Drainer  
**DW30045SET** ● D 13.4cm (5¼")



Square Drip Tray w/Drainer  
**DWD RIP5QSETSS** ● L W 12.7cm (5")

KENNY MACK DESIGNS *spoon rests*



Curved Spoon Rest Shell  
**KMK2804SH** ● 26.7cm (L 10½" W 4¼" H 2")



Curved Spoon Rest Tangerine Pearl  
**KMK2804TGP** ● 26.7cm (L 10½" W 4¼" H 2")



Curved Spoon Rest Tortoise  
**KMK2804TOR** ● 26.7cm (L 10½" W 4¼" H 2")

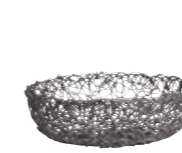

Bronze Finish Basket  
**7340MW010** ●  
23.0cm x 7.0cm H (9" x 2¾" H)  
**7340MW009** ●  
15.75cm x 4.5cm H (6¼" x 1¾" H)

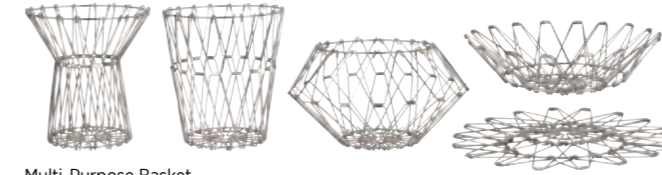

Multi-Purpose Basket  
**7600CV039** ● 31.8cm x 1.9cm H (12½" x ¾" H) When Folded Flat



Round Satin Sugar Holder  
**7600CV014** ●  
5.0cm x 7.0cm H (2" x 2¾" H)



Rectangle Satin Sugar Holder  
**7600CV013** ●  
8.0 x 6.5 x 4.5cm H  
(3⅞" x 2½" x 1¾" H)



Sugar Cube Holder  
Hammered Mirror Finish  
**7340MW013** ●  
4.1cm x 4.5cm H (1⅝" x 1¾" H)



Hammered Mirror Finish  
Sugar Packet Holder  
**7340MW006** ●  
9.75 x 5.0 x 6.75cm H  
(3⅞" x 2" x 2⅝" H)



Mirror Finish Salt & Pepper Set  
**7600CV001** ●  
4.5cm x 8.25cm H  
(1¾" x 3¼" H)



Satin Oval Salt & Pepper Set  
**7600CV002** ●  
3.8 x 2.5 x 6.5cm H  
(1½" x 1" x 2½" H)



Hammered Rectangular  
Salt & Pepper Set  
**7600CV022** ●  
3.0cm x 5.0cm H (1¼" x 2" H)



Angled Salt & Pepper Shaker  
**7347MW160** ●  
4.8cm x 4.4cm H (1⅞" x 1¾" H)  
Replacement Stopper  
**7347MW161** ●  
(Fits 7347MW160)



Satin Fry Cup  
**7600CV006A** ●  
9.75cm x 7.6cm H  
(3⅞" x 3" H) 34.0cl (12oz)



Hammered Fry Cup  
**7600CV018A** ●  
10.0cm x 7.25cm H  
(4" x 2⅞" H) 34.0cl (12oz)



Hammered Cup  
**7600CV019** ●  
8.5cm x 5.0cm H  
(3⅞" x 2" H) 17.0cl (6oz)



Satin Sauce Cup  
**7600CV010** ● 7.6cm x 4.5cm H (3" x 1¾" H) 15.5cl (5½oz)  
**7600CV012** ● 5.0cm x 3.8cm H (2" x 1½" H) 5.7cl (2½oz)  
**7600CV023** ● 3.8cm x 2.5cm H (1½" x 1" H) 4.25cl (1½oz)



Ramekin Satin  
**7600CV025A** ●  
6.0cm x 4.1cm H  
(2⅝" x 1⅝" H) 5.7cl (2½oz)  
**7600CV009A** ●  
6.5cm x 2.5cm H (2½" x 1" H)  
5.0cl (1¾oz)



Hammered Ramekin  
**7600CV024A** ●  
6.0cm x 4.1cm H  
(2⅝" x 1⅝" H) 5.7cl (2½oz)  
**7600CV008A** ●  
6.5cm x 2.5cm H (2½" x 1" H)  
5.0cl (1¾oz)



Hammered Shallow Bowl  
**7600CV017** ●  
9.75cm x 3.8cm H  
(3⅞" x 1½" H) 23.75cl (8½oz)



Trio Snack Holder  
**7600CV034** ●  
17.75cm x 4.5cm H (7" x 1¾" H)  
17.0cl (6oz) Each Cup



Satin Creamer  
**7600CV028** ●  
6.5cm x 6.75cm H  
(2⅝" x 2⅝" H) 15.5cl (5½oz)  
**7600CV029** ●  
6.0cm x 4.5cm H  
(2⅝" x 1¾" H) 10.0cl (3½oz)



Satin French Fry Cup  
**7600CV016** ●  
8.75 x 7.0 x 10.75cm H  
(3½" x 2¾" x 4¼" H)  
37.0cl (13oz)



Fry Basket  
**7600CV011** ●  
10.5 x 9.25 x 6.75cm H  
(4⅞" x 3⅝" x 2⅝" H)  
(Basket Size w/out Handle)



Wire Fry Cone  
**7600CV020** ●  
8.75cm x 8.75cm H  
(3½" x 3½" H)



Satin Taco Holder (For 2 or 3)  
**7600CV007** ●  
15.5 x 8.25 x 3.0cm H  
(6⅞" x 3¼" x 1¼" H)



Mirror Finish Water Pitcher  
**7345MW107** ●  
20.25cm x 26.6cm H (8" x 10½" H)  
398.0cl (3½qts)



Satin Base Insulated Coffee Pot  
**7502WL002** ●  
15.25cm x 22.25cm H (6" x 8¾" H)  
145.0cl (51oz)  
**7502WL001** ●  
14.5cm x 18.75cm H (5¾" x 7⅝" H)  
96.6cl (34oz)



Stainless Steel Gravy Boat  
**7350MW201** ●  
20.0cm x 11.75cm H  
(7⅞" x 4⅝" H) 28.5cl (10oz)



Butter Dish  
**7347MW136** ●  
8.3cm x 5.7cm H (3¼" x 2¼" H)



Satin Round Card Holder  
**7600CV004** ● 3.0cm (1¼")



Satin Square Card Holder  
**7600CV005** ●  
3.8 x 4.1 x 3.5cm H  
(1½" x 1⅝" x 1⅝" H)

*metal accessories to fit every niche*

From traditional round hammering and rim embossments to stainless steel wire baskets and french fry cups, the Creations Metal collection has it all. Available in various finishes, shapes and sizes, Creations Metal provides that something extra every buffet or tabletop seeks.



*eliminate spills & splashes*

Make a statement with your beverage service with Royce stainless steel hollowware from Creations. The easy to hold, slanted ergonomic handle allows servers to balance and pour beverages with perfection, while the brushed finish provides a sleek look and reduces the appearance of fingerprints. Royce's tall & slender body will reduce the footprint on the table or buffet, and clever features like longer spouts and ice guards will help eliminate a majority of spills & splashes.

*leave a lasting impression*

Create an experience guests will remember with the Williamsburg Metalworks Tray collection. These eye-catching trays come in multiple sizes, providing options for table service, room service, and hotel amenities. From the wine coaster to the appetizer platter, these pieces are sure to create a lasting impression.



Coffee Pot w/Long Spout  
**7347MW153** ●  
(2qt)



Water Pitcher w/Ice Guard  
**7347MW152** ●  
(2qt)



Teapot w/Lid  
**7347MW148** ●  
(17oz)



Creamer w/Cover  
**7347MW145** ●  
(9oz)



Sugar Bowl w/Cover  
**7347MW143** ●  
Replacement Lid  
**7347MW151** ●



Salt & Pepper Set  
**7347MW147** ●  
Replacement Stopper  
**7347MW149** ●  
(Fits 7347MW147)



Round Tray  
**5851JX35** ● D 40.0cm (15¾") 33.0cm (13") Well  
Satin Finish Inside And Mirror Finish On Flange



Rectangular Tray  
**5851JX32** ● 33.0cm x 25.4cm (13" x 10")  
Well 25.4cm x 17.8cm (10" x 7")  
Satin Finish Inside And Mirror Finish On Flange



Wine Coaster  
**5852JX40** ● D 14.6cm (5¾")  
Satin Finish



## Serving Utensils

Even the serving utensils should bring style and refinement to a buffet presentation. Steelite proudly offers exceptional 18/10 stainless steel collections from Folio & D.W. Haber.



*spoons, ladles, tongs and more*

No buffet presentation would be complete without its serving utensils. From a clean and sleek look to a fingerprint-free hammered finished, D.W. Haber offers a variety of 18/10 stainless steel utensils that are suitable for foodservice.

*chicago serving utensils ★★★★★*



**DW397CS** Pie/Cake Server 25.4cm (10")  
**DW397SVSPP** Slotted Serving Spoon Large 29.2cm (11½")  
**DW397SVSP** Solid Serving Spoon 29.2cm (11½")  
**DW3979SVSP** Serving Spoon Medium 22.9cm (9")  
**DW3978SVSP** Serving Spoon Small 22.9cm (9")  
**DW397SVFK** Serving Fork Large 30.5cm (12")  
**DW394ICE** Ice Scoop 20.3cm (8")

*hammered serving utensils ★★★★★*



**DW398MLAD4** Ladle, Soup/Punch 33.0cm (13") 11.8cl (4oz)  
**DW398MLAD1** Ladle 30.5cm (12") 3.0cl (1oz)  
**DW398MPL** Pie Lifter 27.9cm (11")  
**DW398MSVSPP** Slotted Serving Spoon Large 33.0cm (13")  
**DW398MSVSP** Serving Spoon Large 33.0cm (13")  
**DW3981MSVSP** Serving Spoon Medium 26.7cm (10½")

*roma serving utensils*



**DW397LADGR** Gravy Ladle 16.5cm (6½") 1.5cl (½oz)  
**DW397LAD1** Ladle 30.5cm (12") 3.0cl (1oz)  
**DWH397LAD4** Ladle 31.8cm (12½") 11.8cl (4oz)  
**DW397LAD8** Ladle 35.6cm (14") 23.7cl (8oz)  
**DW394SVSP** Solid Serving Spoon w/ Roma Handle 31.8cm (12½")  
**DW394SVSPP** Pierced Serving Spoon w/ Roma Handle 31.8cm (12½")

*tongs*



**DW396ST9** Serving Tong 22.9cm (9")  
**DW39468** Serving Tong w/ Notched Ends 20.3cm (8")  
**DW39462** Ice Tong 17.8cm (7")  
**DW39461** Sugar Tong 12.7cm (5")  
**DW398MST10** Hammered Salad Tong 25.4cm (10")  
**DW398MST9** Hammered Serving Tong 24.1cm (9½")  
**DW398MST8** Hammered Ice Tong 20.32cm (8")  
**DW396PST** Pastry Scissor Tong 20.32cm (8")

D=Diameter L=Length W=Width H=Height • All Products are Measured at Max Capacity (oz)

• Non-Stock



*essential for foodservice*

Considered by some to be 'perfection in the hand'. The Radford collection has a softness and ergonomic curve which is both classic and contemporary. The Radford design is versatile enough to complement any table setting. With over 60 pieces, Radford stainless steel flatware and serving utensils offer a solution for any dining occasion.

- |   |   |   |   |  |   |  |
|---|---|---|---|--|---|--|
| <br>Salad Serving Spoon<br><b>5970SX062</b> ●<br>27.0cm (10.63") | <br>Serving Spoon<br><b>5970SX061</b><br>23.0cm (9.06")                                    | <br>Slotted Spoon<br><b>5970SX060</b> ●<br>(10 <sup>5</sup> / <sub>8</sub> "") | <br>Gourmet Serving Spoon<br><b>5970SX080</b> ●<br>25.7cm (10.12") | <br>Salad Serving Fork<br><b>5970SX071</b> ●<br>26.4cm (10.39")                         | <br>Serving Fork<br><b>5970SX072</b><br>23.5cm (9.25") | <br>Pie Server<br><b>5970SX031</b> ●<br>25.0cm (9.84")    |
| <br>Ice Tongs<br><b>5970SX073</b> ●<br>17.0cm (6.69")            | <br>Serving Tongs Small<br><b>5970SX036</b> ●<br>17.3cm (6 <sup>7</sup> / <sub>8</sub> "") | <br>Serving Tongs<br><b>5970SX190</b> ●<br>23.4cm (9.21")                      | <br>Snail Tongs<br><b>5970SX194</b> ●<br>17.3cm (6.81")            | <br>Sugar Tongs<br><b>5970SX317</b> ●<br>10.8cm (4.25")                                 | <br>Ice Scoop<br><b>5970SX188</b> ●<br>21.4cm (8.43")  | <br>Stilton Scoop<br><b>5970SX265</b> ●<br>20.0cm (7.87") |
| <br>Stilton Scoop (H.H.)<br><b>5970SX266</b> ●<br>20.0cm (7.87") | <br>Sauce Ladle<br><b>5970SX065</b> ●<br>17.0cm (6.69")                                    | <br>Soup Ladle<br><b>5970SX063</b> ●<br>32.0cm (12.6")                         | <br>Lobster Pick<br><b>5970SX028</b><br>21.4cm (8.43")             | <br>Napkin Ring Set 2-Piece<br><b>5970SX267</b> ●<br>(2 <sup>3</sup> / <sub>4</sub> "") |   |  |



**5970SX180** ●  
Carving Set



**5970SX181** ●  
Cheese Knife 5 Piece  
Gourmet Set



*multi-piece sets*

**5970SX268** ●  
Cheese Set Small  
4-Piece 8<sup>1</sup>/<sub>4</sub>"



ROBERT WELCH *signature 18/10*

All Signature utensils feature comfortable rounded handles with a lipped end. Made from the finest 18/10 stainless steel, each utensil has been designed with its specific purpose in mind and to maximise ease of use. Ideal as a hanging set as well as serving pieces at the table.

- |   |  |   |  |   |
|---|--|---|--|---|
| <br>Ladle Large<br><b>5979SX063A</b><br>32.0cm (12.6") | <br>Ladle Small<br><b>5979SX065A</b><br>26.0cm (10.24") | <br>Serving Spoon Small<br><b>5979SX066</b><br>26.0cm (10.24") | <br>Serving Fork Large<br><b>5979SX072</b><br>33.0cm (12.99") | <br>Pie/Flan Server<br><b>5979SX031</b><br>30.0cm (11.81") |
|---|--|---|--|---|





Bryce's stainless steel cutlery features a high quality, 18/10 stainless steel finish and has expanded to a line of serving utensils. With a classic design, create a seamless look from tabletop to buffet with these simply elegant serving pieces.

- 18/10 stainless steel serving utensils
- High quality mirror polished finish
- Modern look, designed for buffet
- Extensive range



The contemporary and unique design of the Angle serving pieces feature a convenient curve on the brushed satin handles that make it easy to hold and perfect for banqueting.

- 18/10 stainless steel
- High quality mirror polished finish
- Brushed satin handle
- Modern design with an elevated handle for ease of use

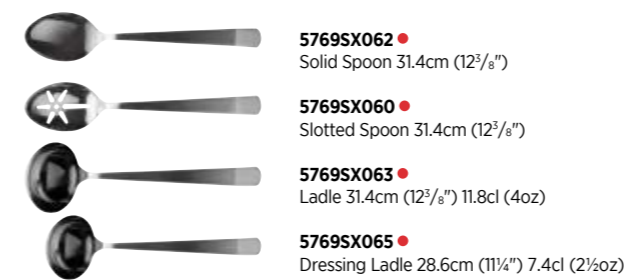



*modern and sleek*

The Idol™ serving pieces are inspired by the modern styling of Idol™ chafers. The sleek hollow handles dissipate heat keeping them comfortable to the touch even when left in heated food pans. The handles also highlight a convenient, curved design, making it easier to pick up off the table.

*durability and style*

Made of durable 18/10 stainless steel, Walco Ultra serving utensils feature a classic rim design with long handles and a polished mirror finish. Manufactured to hotel weight standards, Ultra will withstand the rigours of foodservice.

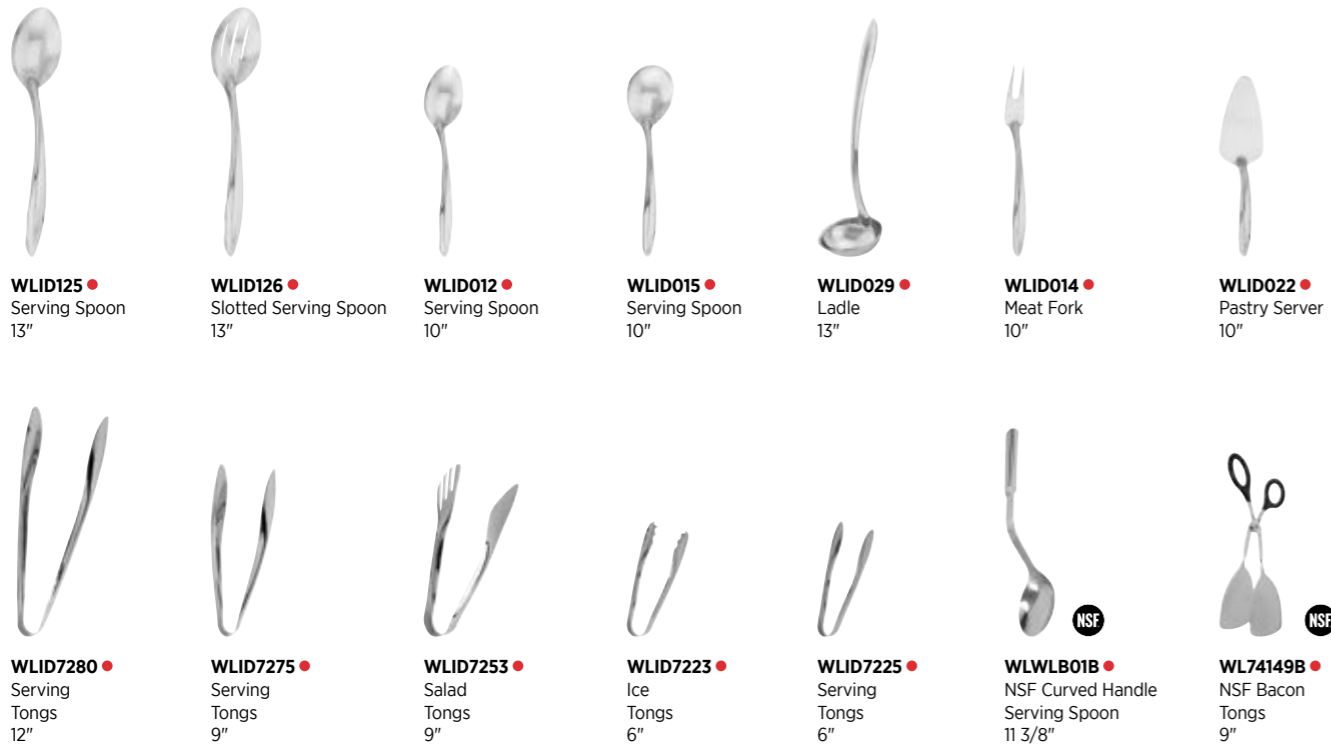



**MTPLL011216**  
Linen Silicone Placemat  
Chocolate  
30.5cm x 40.6cm (12" x 16")



**MTPLL021216**  
Linen Silicone Placemat  
Denim Blue  
30.5cm x 40.6cm (12" x 16")



**MTPLL071216**  
Linen Silicone Placemat  
Black Grey  
30.5cm x 40.6cm (12" x 16")



**MTPLST201216**  
Stream Silicone Placemat  
Silver  
30.5cm x 40.6cm (12" x 16")



**MTPLTW041216**  
Twine Silicone Placemat  
Silver  
30.5cm x 40.6cm (12" x 16")



**MTPLHA071216**  
Hatch Silicone Placemat  
Black Grey  
30.5cm x 40.6cm (12" x 16")



**MTPLMA071216**  
Marble Silicone Placemat  
Grey  
30.5cm x 40.6cm (12" x 16")



**MTTVHI00407**  
Hive Trivet Midnite  
17.8cm (7")



**MTTVHI00107**  
Hive Trivet Cloud  
17.8cm (7")



**MTTVHI00307**  
Hive Trivet Graphite  
17.8cm (7")



**MTTRLI011472**  
Linen Silicone Table Runner  
Chocolate  
35.6cm x 182.9cm (14" x 72")



**MTTRLI071472**  
Linen Silicone Table Runner  
Black  
35.6cm x 182.9cm (14" x 72")



**MTTRST201472**  
Stream Silicone Table Runner  
Silver  
35.6cm x 182.9cm (14" x 72")

***the evolution of a functional linen for tabletop***

Modern-twist inspires a better dining experience through design, function, and social responsibility by producing innovative, quality products. Using pure, hand printed silicone, Modern-twist has successfully created a line of placemats, table runners and trivets that are eco-friendly and 100% food safe. Currently used in top hotels, restaurants and airports worldwide, these linens are commercial dishwasher safe, BPA free, and have no memory so they always lay flat. With a look as elegant as cloth and more functional than vinyl, Modern-twist is the perfect addition to your dining room table.

D=Diameter L=Length W=Width H=Height • All Products are Measured at Max Capacity (oz)



## Care & Use Guide

Seventy percent of product damage/loss occurs at the dishwasher table. To avoid such damage, ensure that the dishwasher table has sufficient space to store dirty items and avoid overloading trays or trolleys. All items should be separated into type prior to washing. All washing equipment chemicals should be maintained and checked regularly. Check stock often; storage facilities should allow for stock rotation to prevent overuse.



### *fusion buffet system*

#### **TEAK WOOD FINISH**

- Not dishwasher safe.
- Use a soft cloth with water to wipe down surface.
- Do not use any chemical products or abrasives.

#### **TEFLON AND STAINLESS-STEEL COATING**

- Dishwasher safe.
- Clean in dishwasher or use a soft cloth sprinkled with a few drops of dishwashing liquid to wipe Teflon surface cleans. Wipe off soapy residue with a damp cloth.
- A stainless-steel cleaner can be used to polish stainless steel risers.

#### **TILE INSERTS - RESIN, TEAK WOOD, AND GLASS**

- All dishwasher safe, except for wood tiles. Never put wood in the dishwasher.
- Teak wood - wipe down with a soft damp cloth and few drops of dishwashing liquid. Wipe off residue with a soft cloth.
- Resin and Glass - dishwasher safe.

### *creations wood*

To best maintain product finish and condition:

- Do not place near an open flame or grille
- Products should be stored in a dry location at room temperature.
- Do not store near heat sources or in humid places.
- **This product should not be used in the dishwasher, oven, microwave or freezer.**
- Clean with a soft damp cloth or wash with hot soapy water, do not soak in water or wash with harsh detergents.
- Sanitise using an antibacterial spray or food safe liquid sanitiser.

- Dry promptly after cleaning, ensure products are dry before stacking.
- In order to maintain product finish and condition, apply a light coat of mineral oil with a clean dry cloth, to prevent wood from drying and cracking.
- Do not leave in direct sunlight for long periods of time.

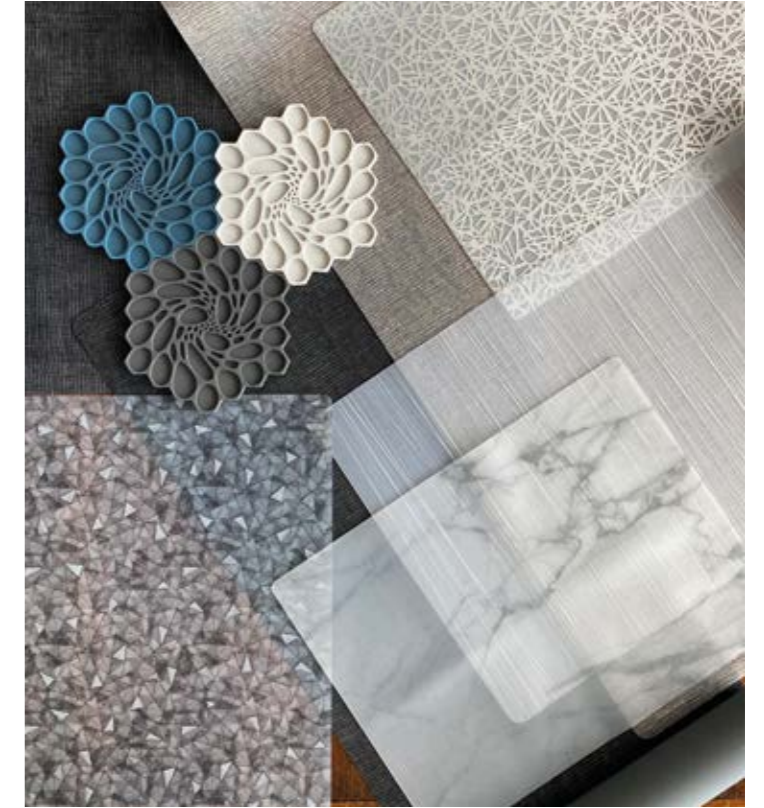

### *kenny mack resin*

- Dishwasher and food safe.
- Product doesn't stain however on darker colours a white film may develop over time due to drying agents. If this occurs, wiping the surface with any type of oil will bring back the original colour.

- If any chipping occurs, use light sandpaper or a rough sponge to buff and smooth down the chip.

### *modern twist*

- All products are free of byproducts and fillers.
- No BPA, PVC, lead, latex or phthalates.
- Dishwasher safe on the top rack.
- Keep away from sharp objects.
- To prevent staining rinse or wipe with a damp cloth after each use.
- Do not use chemical sprays.

#### **PLACEMATS**

- Hand printed pure silicone, non-porous, food grade and plastic-free.
- High heat resistance up to 425°F / 220°C (not to be used as a trivet).

#### **TABLE RUNNERS**

- Silky, non-porous, food grade + germ-free silicone.
- High heat resistance up to 425°F / 220°C (not to be used as a trivet).

#### **TRIVETS**

- Pot holder + trivet, the interlocking design turns the trivets into a table runner.
- High heat resistance up to 675°F / 355°C.



## melamine

### DO

- Melamine products are commercial dishwasher safe.
- Clean as soon as possible to help avoid staining and protein build-up.
- Immediately remove any damaged or chipped melamine products from operational use.
- Melamine products can withstand heat up to 212°F (100°C).

### DO NOT

- Do not use in oven, microwaves or expose to direct flame, this can cause cracking and blistering from the heat.
- Do not use with heat lamps, conveyor belts, or plate warmers.
- The use of serrated knives is not recommended on melamine products.
- To avoid chipping and scratching, do not strike melamine products with or on any hard surface while attempting to remove excess food.

### DESTAINING

- Periodically presoak melamine products before dishwashing to prevent staining and to maintain lustre.
- For staining, use an oxygen-releasing compound such as Dip-It XP (ECOLAB).
- Sponges or woven plastic pads are recommended for cleaning.
- Do not use harsh or abrasive cleaners, steel wool, or metal pot scouring pads to remove food or stains.

### DISHWASHING

- Refer to a qualified technician to establish a maintenance schedule for your dishwashing system to ensure proper temperatures, chemical levels, and mineral content.
- Only use sanitisers developed for commercial use.
- To avoid chipping and scratching, do not overload your dishwasher rack.
- Do not use chlorine bleach or chlorine-based sanitising solutions when caring for melamine products.

### Recommended ECOLAB detergents:

- Apex Power Plus (high-temp)
- Apex Ultra (hard water, high-temp)
- Fast Drying Rinse (ideal for plasticware)
- Solid Power XL (high-temp)
- Solid Ultra Klene Plus (low-temp)

### Recommended ECOLAB rinse agents:

- Apex HD Rinse Aid (hard water, high-temp)
- Apex Rinse Additive (high-temp)
- Rinse Dry (high-temp)
- Solid Brilliance (high-temp)
- Ultra Dry (low temp)

### Recommended ECOLAB sanitisers:

- Eco San (low temp)
- Ultra San (low temp)



## folio cookware

- Cast Aluminium provides an unbreakable body, is an excellent heat and cold conductor and is at least 50% lighter than cast iron. Folio Cookware has a 4-Ply ceramic non-stick coating, in which food will release easily from the pan, is easy to clean with warm soapy water and soft cloth or sponge, and no oil or cooking spray is needed.
- All Folio Cookware items can be used in an oven, up to 450°F (230°C). Cooking pots can also be used on electric or gas cooktops, as well as on induction cooking and warming tops.

### CROCKS & CASSEROLES



OVEN

### COOKING POTS

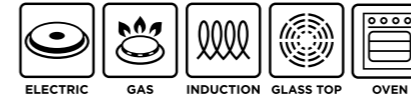

ELECTRIC

GAS

INDUCTION

GLASS TOP

OVEN

**While Folio Non-stick Cookware performs better than most non-stick cookware, it is not scratch proof, the life and beauty of the non-stick coating can be prolonged with best care and use practices:**

### DO

- Do use non-metal serving utensils.
- Do use soft pads or brushes to remove residue before washing.
- Do clean in a dishwasher - high temp/low chemical is best.
- Do separate cookware in dish racks so they do not touch.
- Do always use a thick cloth or oven mitts to handle hot cookware.

### DO NOT

- Do not use with knives.
- Do not use with metallic serving utensils.
- Do not use metallic scouring pads, green scrubbers, or abrasive cleaners.
- Do not use in microwave oven.
- Do not season cookware with cooking oils or non-stick sprays.

## chafers & marmites

### STAINLESS STEEL

- Exterior frame and food pans are dishwasher safe.
- The chafing dish frame and cover may be cleaned with warm, soapy water or in the dishwasher.
- The induction water pan should be hand washed.
- Occasionally the frame may need polishing. Use a stainless-steel cleaner or glass cleaner without ammonia.
- Over time the water pan may accumulate water deposit. This can be removed with a de-liming solution.

### HOMESTYLE CAST IRON CHAFERS - TEFLON COATING

- Dishwasher safe.
- Rinse with warm water and use a soft nylon brush to remove stuck-on bits before loading in the dishwasher.

### FOOD PANS

- Dishwasher safe.

### INDUCTION RANGES

- Not dishwasher safe.
- Avoid abrasive cleaners and scouring pads.
- Allow the surface to cool before cleaning.
- Wipe clean using a soft cloth and mild dishwashing liquid soap. Wipe off soap residue with a damp cloth.



### heater stands

- Dishwasher safe.
- For aluminium hot plates and grills, a degreaser can be used to remove black stains from fuel use.

### induction range

- Avoid abrasive cleaners and scouring pads.
- Allow the surface to cool before cleaning.
- Wipe clean using a soft cloth and mild dishwashing liquid.
- Wipe soap residue with a soft damp cloth.

### heat lamps

- Not dishwasher safe.
- Make sure power is switched off before servicing unit.
- Unplug the unit from the power source.
- Allow lamps to cool before cleaning the unit or replacing bulbs.

- Remove bulbs and use a mild detergent such as dishwashing liquid with a soft sponge or cloth to wipe down.
- Dry with a soft cloth. Completely dry before the next use.
- Do not immerse the unit in water and never use abrasive or scouring powders.

### carving boards

#### WOOD BOARDS

- Not dishwasher safe.
- Hand wash the board immediately after use with water and dishwashing soap.
- Pat the board dry with a paper towel or dishtowel immediately after cleaning.
- To maintain and extend the board life, season weekly, bi-weekly or monthly by wiping food-grade mineral oil over your dry board's exterior. Let the oil sit for a few hours. Wipe off excess oil with a dry cloth.

- Never use olive or vegetable oil to season a carving board.

**WHITE POLY BOARD** Dishwasher safe

**BLACK GRANITE** Dishwasher safe



### beverage urns, milk & cereal dispensers

#### JUICE & BEVERAGE URN, MILK DISPENSER

- Components are not dishwasher safe.
- Do not use abrasive products.
- **Daily:**
  - Remove nozzles and diffusers and soak them in warm, soapy water.
  - Use hot water and mild soap to clean inside of dispenser and then rinse thoroughly.
  - Clean outside with a warm wet cloth.
  - Clean spigot by removing rubber seat cup and clean by brushing inside of faucet.
- **Regular Basis:**
  - Flush and clean water lines.

- Never immerse base of Urn in water.
- Clean spigot by removing rubber seat cup and clean by brushing inside of faucet.
- Tip - Use rubber gloves to ensure the faucet is tight when you screw it back on to prevent leakage.
- **De-Staining**
  - Put 1 cup baking soda into your stainless-steel coffee pot and fill with warm water.
  - Use a dish brush to scrub inside of the pot with baking soda solution in it.
  - Pour solution out and thoroughly rinse inside with hot water until it runs clean.

#### COFFEE URN

- **Cleaning**
  - Always rinse urn immediately after each use.
  - Add a small quantity of hot water, brush insides, and rinse with hot water.

#### CEREAL DISPENSER

- Disassemble all parts and clean interior with warm soapy water, rinse thoroughly.
- All parts should be completely dry before reassembling.

### stainless steel display items (cold buffet & wine)

- Dishwasher safe.
- Do not use steel pads, wire brushes or scrapers. Do not use powders, or cleaners that contain chlorides, bromides or iodides.
- Always rinse thoroughly with fresh water after every cleaning operation.
- Wipe unit dry with a soft cloth to remove water.
- Always rub in the direction of the steel grain for maximum effectiveness to avoid marring the surface.
- For smears or fingerprints, wipe with a clean slightly damp cloth. If that doesn't work, use a stainless-steel commercial cleaner.



### china

- Should be washed within 45 minutes of removal from the table and pre-rinsed.
- Avoid contact between china, dinnerware and metals.
- Abrasive cleaning aids should not be used, i.e. scouring pads, steel wool, etc.
- Minimise handling to reduce glaze abrasion.
- Do not stack more than 15" high.
- Do not slide items across each other to reduce abrasions.

- Be sure to rotate your stock to prevent uneven wear.
- Only stack product that are designated stackable.

#### CUSTOM DECORATED CHINA

- Gold and platinum decorations are not microwave safe.
- Hand washing is recommended to prolong the metallic lustre of decoration.

### glassware

- After washing, remove basket and leave to cool and dry.
- Never carry glasses in bouquets.
- Never use glass to carry or store cutlery.
- Never let the beer tap come in contact with the glass.
- Do not use glassware as an ice scooper.
- Use properly sized compartmented glass racks.

### stemware

- Do not handle the stemware when hot.
- Use white cotton gloves or 2 cloths for polishing
- Polish the bowl first followed by the stem and then the base.
- Do not hold the glass by the stem or the base when polishing the bowl.
- Use properly sized compartment glass racks.

### aspen & strahl drinkware

- Dishwasher & freezer safe.
- Items must be carefully placed in the dishwasher while avoiding direct contact with other dishes and drinkware.
- Do not wash with harsh abrasives such as brushes or scrubber pads as this may cause scratches; harsh chemicals including strong acid or alkali cleaning agents should also be avoided.
- Use warm, soapy water or a neutral dishwashing liquid for cleaning.
- Dry naturally or with a soft cloth after hand washing; we recommended using a microfibre cloth to preserve clarity.

- Product can be used normally between temperatures of -30°C and 110°C (-22°F and 230°F).
- Avoid prolonged exposure to UV light, sunscreen or chlorine.
- Not recommended for use in microwaves or high temperature sterilisers.

#### POLYPROPYLENE LIDS, STOPPERS & BOTTOMS

- Do not use strong acid or strong alkaline cleaning agents.
- Temperature should not exceed more than 104°F (40°C).
- Avoid excessive water pressure as well as objects pressing on the product or it may cause deformation.



### cutlery

- Cutlery should be washed separately from dinnerware.
- Wash as soon as possible to prevent pitting from acidic food deposits.
- A pre-soak in warm water is recommended to loosen food particles.
- Make sure your cleaning agent is void of any abrasive or corrosive qualities.
- Use upright baskets to prevent scratching and to aid drying.



- Do not overfill the upright cutlery baskets.
- If using a low temperature dishwashing system, carefully follow the manufacturer's instructions to avoid staining or corrosion.
- On completion of the wash, allow the cutlery to air dry, hand dry if necessary.
- Be sure cutlery is completely dry before storing in a dry location away from the kitchen.

### steak knives

#### WOOD HANDLED KNIVES

- Handwashing is recommended for the best performance and optimal product life.
- Wash knives with warm water and a mild detergent, rinse well and dry thoroughly.
- Water and harsh detergents will dull the finish and dry out the handles.
- It is recommended that the wooden handles be oiled as needed.

#### ABS (RESIN) HANDLED KNIVES

- Low temp dishwasher safe.
- Wash knives with warm water and a mild detergent, rinse well and dry thoroughly.
- Not recommended for high temp dishwashers that exceed 167°F / 75°C.
- Knives should not be exposed to extreme temperature changes, which will cause the abs handle material to crack over time.

#### STAINLESS STEEL KNIVES

- Dishwasher safe.
- Wash knives with warm water and a mild detergent, rinse well and dry thoroughly.

#### BLADE SHARPENING

- Serrated blades cannot be sharpened.
- Blades with no serrations can be sharpened as needed.
- The frequency will depend on how often the knives are used and how well they are maintained.

#### THINGS TO AVOID

- Avoid soaking knives; they should be cleaned immediately after use to prevent damage caused by certain foods.
- Avoid using abrasive cleaners, scouring pads, oven cleaners or cleaners containing chlorine bleach or citric extracts.
- Avoid cutting on hard surfaces such as stone, metal or glass.



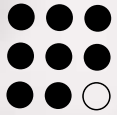

# steelite

INTERNATIONAL

## Benelux

Steelite International Benelux BV  
's Gravelandseweg 258  
3125 BK Schiedam  
Nederland  
Telephone +31 (0)20 617 5915  
Email info@steelite.nl

## Germany

Steelite International  
Deutschland GmbH  
Philipp-Reis-Straße 16  
64404 Bickenbach  
Telephone +49 (0)6257 61950  
Email germany@steelite.com

## France

Telephone +33 682 574 291  
Email france@steelite.com

## Italy

Telephone +39 0522 902051  
Email italy@steelite.com

## Portugal

Rua Brito Pais, 4C - Loja - Miraflores  
1495-028 Algés  
Telephone +351 215 839 333  
Mobile +351 918 550 429  
Email jq@hotelrestaurantco.com

## Scandinavia

Telephone +46 730 322 818  
Email scandinavia@steelite.com

## Spain

Steelite International Spain  
Médico Andrés Boldó, 2  
03005 Alicante  
Telephone +34 966 590 300  
Email spain@steelite.com

## Madrid Showroom

Calle Serrano, 27, 6th Floor,  
28001 Madrid  
Telephone +34 910 400 870  
Email madrid@steelite.com

## Russia, Central & Eastern Europe

CECUK Ltd  
Coleridge House, Suite 47  
2-3 Coleridge Gardens  
London, NW6 3QH  
Telephone 0044 207 435 9033  
Mobile 00777 613 5088  
Email rcee@steelite.com



[www.steelite.com](http://www.steelite.com)

f steeliteinternationalEMEA

X steeliteEMEA

@ steelite\_emea

## Showrooms available by appointment:

Atlanta • Bickenbach, Germany • Chicago • Hong Kong • London, UK • Los Angeles • Madrid • Miami  
New York • Stoke-on-Trent, UK • Sydney, AUS • Toronto, ON • Washington, D.C. • Youngstown, OH