

Buffet



NEW "Glow"





"Glow" - reframing the buffet!

Filigree displays and frames with integrated lighting form the basis of the "Glow" system.

The matt black coating of these slim but still extremely sturdy lighting objects remains discreetly in the background and leaves the presentation of dishes to the warm and glare-free light.

"Glow" is a flexible system that creates unmatched buffet stagings. The filigree construction not only allows food and beverages to be presented on the displays, their inner side also creates enough space to effectively present delicacies in the right light.

All elements can be used lying or upright and create presentation levels at different heights – the basis for varied

and appealing buffet arrangements. Two connecting boards made of bent sheet metal can be attached as desired and thus enable the flexible construction of several elements – even across corners. Matching buffet platters made of glass or laminated plastic, as well as trays made of melamine, complete the system.

Zieher buffet systems have been inspiring with innovative lighting concepts for many years. In "Glow", this is now firmly integrated for the first time. The resulting subtle look of these lighting objects creates completely new facets of an atmospheric buffet ambience.

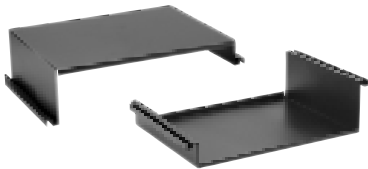

connecting board "Glow" L

steel, matt black (powder coating), usable on both sides, for placement between 2 LED displays (items 8400...) and -frames (items 8405...)

item	l x w x h in cm
8410.16	63.2x36.6x16.2

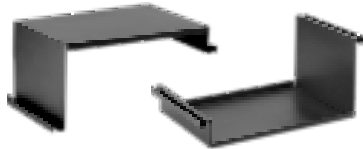

connecting board "Glow" M

steel, matt black (powder coating), usable on both sides, for placement between 2 LED displays (items 8400...) and -frames (items 8405...)

item	l x w x h in cm
8410.24	55.2x32.6x24.2



8400.24 + 8010.02



8400.16 + 8010.01

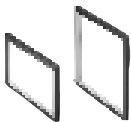

LED frame "Glow"

steel, matt black (powder coating), with circumferential LED stripe (warmwhite), incl. connection for power supply

item	l x w in cm	size
8405.16	32x16	S
8405.24	32x24	M

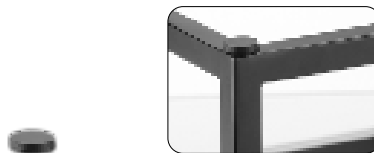

spacer/buffer

magnetic, black, rubberised, for non-slip and noiseless placement under buffet platters and trays on LED Displays GLOW (items 8400...)

item	Ø in cm	thickness in mm	PU
8414	1.7	4.4	4 pcs

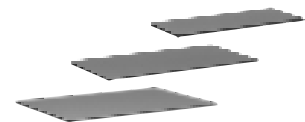

buffet platter, laminated plastic

laminated plastic, 8 mm thick, black, black intermediate ply, break-proof, scratch-proof, dishwasher-safe, antistatic, deburred edges, rounded corners

item	l x w in cm	for LED display
8010.01	41x17	S
8010.02	49x25	M
8010.03	49x33	L

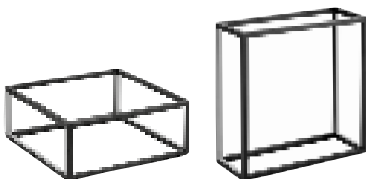

LED display "Glow" S

steel, matt black (powder coating), with 2 circumferential LED stripes (warmwhite), incl. 2 connections for power supply and -forwarding

item	l x w x h in cm
8400.16	40x40x16

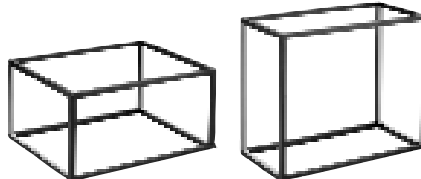

LED display "Glow" M

steel, matt black (powder coating), with 2 circumferential LED stripes (warmwhite), incl. 2 connections for power supply and -forwarding

item	l x w x h in cm
8400.24	48x40x24

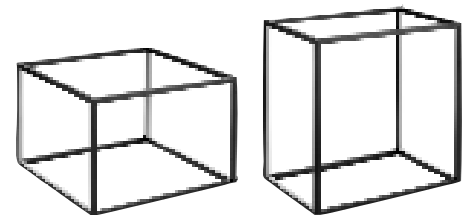

LED display "Glow" L

steel, matt black (powder coating), with 2 circumferential LED stripes (warmwhite), incl. 2 connections for power supply and -forwarding

item	l x w x h in cm
8400.32	48x48x32



Components of the system:

- The illuminated cuboids offer the possibility of operating up to three elements on one power supply, due to the two integrated connection sockets.
- Illuminated frames can be placed horizontally and thus enable the effective lighting of translucent buffet platters of all kinds. When set up, they fit into the height grid of the buffet cuboids and thus function as a space-saving support for attached connecting boards.
- The connecting boards are made of powder-coated sheet metal and allow a two-sided use. They can simply be hung between the cuboids and frames, creating additional presentation levels and areas.
- Precisely fitting glass platters of various types and platters made of black laminated plastic make it possible to quickly and easily close the top of the illuminated cuboids. Various melamine trays from the range can also be used on some of the cubes. In the lying position, there is a large selection of suitable glass platters from the Zieher range available (50 x 50cm / 50 x 42cm / 42 x 42cm). These buffet platters are available on pages 50 to 57. If the cuboids are positioned upright, they can be covered with laminated plastic platters.
- Rubberised magnetic buffers ensure the non-slip and noiseless support of all platters and trays. These are available as accessories and can be placed anywhere on the displays and frames. Furthermore, they create the necessary distance in order to place glass or laminated plastic platters in spite of the attached connecting boards.



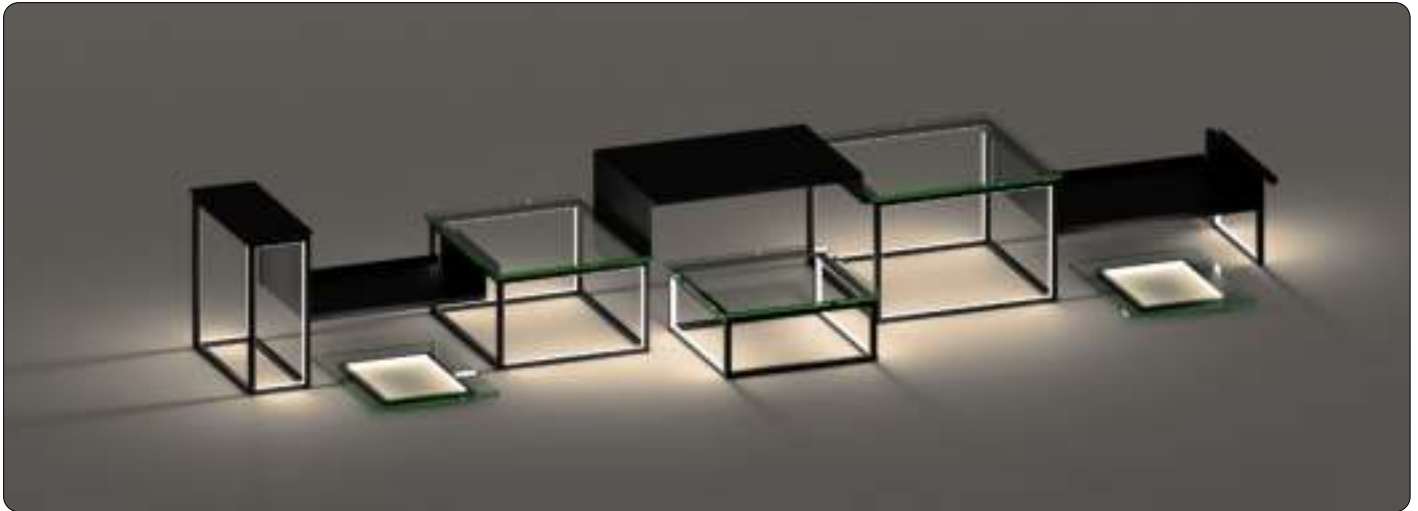

Accessories LED lighting:

- The power supplies are available with EU, US and UK plugs. The power of the supplies is sufficient to connect up to three cuboids or frames. Since each cuboid has two connection options, they can be strung together without any problems.
- As they only have one connection option, the two frames form the end of the chain. The energy-efficient LED lighting in warm white colour is operated with harmless 24 volts.
- Connecting cables with angled plugs are available in two lengths and help to keep the number of cables required as low as possible in numerous setups.
- Shapely and reusable cable holders made of durable silicone help to lay and fix power- and connecting cables inconspicuously or to bundle several cables.

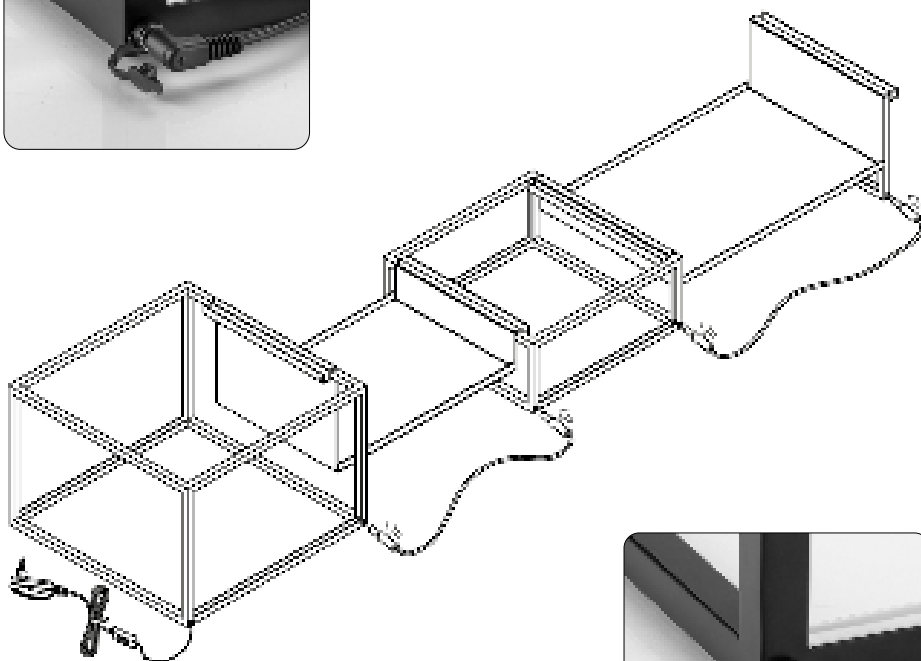
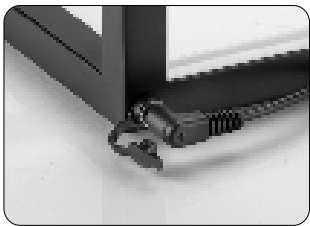

schematic illustration

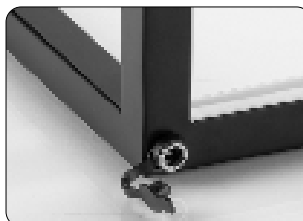

connecting cable "Glow"

black, with angled plugs, for daisy chaining LED displays items 8400... and -frames items 8405...

item	length
8418.01	1 m
8418.02	2 m

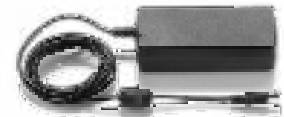

power supply for LED displays and -frames "Glow"

black, 60w, 100-240V, for use with plug item 8416. EU/UK/US (please order separately), suitable for LED displays items 8400... and -frames items 8405...

item	length
8416	1.70 m



plug for power supply 8416

black, length 2 m, with integrated on/off switch

item	power plug
8416.EU	Europe
8416.UK	UK
8416.US	US

Please note:



This power supply is designed for the simultaneous use of a maximum of 3 LED displays or -frames from the "Glow" series!

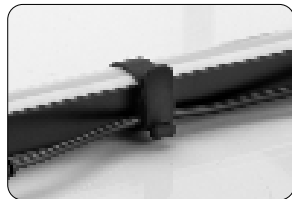

cable holder

silicone, black, length 8 cm, with 3 fastening holes, reusable due to a detachable lock, suitable for guiding cables

item	PU
8412	10 pcs



base tray "Modul"

melamine, black, surface matt, food-safe, dishwasher-safe, not suitable for microwave and combi steam oven

item	l x w x h in cm	PU
4581	53x28x1.8	2 pcs

Please note:



The melamine tray 4581 fits perfectly on the LED display M (item 8400.24) when set up.



More trays and boxes made of melamine are available from page 130 on.

"Textura"



The cloches and porcelain bowls and plates of the series "Cuspis" are available on page 152 and 176.

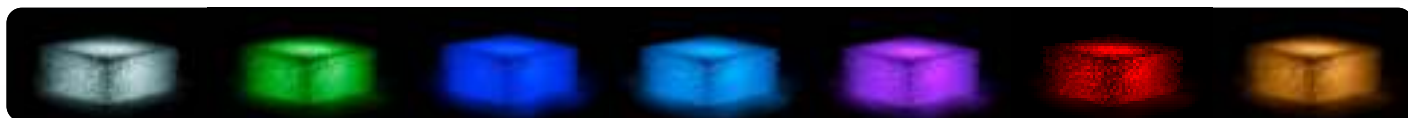

In order to grant a harmonic all-over illumination while using stacked cuboids, it is recommended to use one LED lamp per item. For usage of bigger buffet platters, we suggest to employ the elements with 30 cm edge length. Due to the flexible material, we recommend stacking a maximum of two cubes on top of each other, when the system is equipped with heavy platters or bowls.



precisely fitting recess for ZIEHER LED lights (page 48/49)



buffet display "Textura"

polyethylene, transparent, with notch for rechargeable LED-light item 8150

item	l x w x h in cm
8232.24	approx. 24x24x10.5
8232.30	approx. 30x30x10.5



“Textura” - indestructible, innovative, exclusive!

The exclusive cuboids of the “Textura” series are exceedingly interesting, even at a second glance, due to their awesome structure. They consist of thin polyethylene filaments, which are convoluted intricately and fused together. This awards them a flexible but nevertheless very stable texture. The true potential of this innovative material is only disclosed

in connection with light. The light-conducting properties of the filigree filaments manifest effectively when using the rechargeable Zieher LED light (page 48/49), which fits exactly into the cut-outs on the bottom side of the displays. The “Textura” buffet cuboids are available in two sizes which, when used separately or stacked on top of each

other, create different presentation levels on the buffet. Buffet platters and trays are reliably kept in position due to the non-slip features of this material. “Textura” lives up to the high demands of gastronomy and catering in numerous ways. The displays are indestructible and very light, washable and dirt-repellent. The countless interspaces create a light-flooded meshwork, which dries very quickly and is therefore resistant to humidity and mold. Also the raw material itself is something to be proud of. Polyethylene can repeatedly be 100% recycled without losing its outstanding characteristics. It is physiologically non-hazardous, odorless, tasteless and resistant to a variety of acids, oils and grease.



All information about the cooling elements “Chiller Base” can be found on pages 42 and 43

"Somnia"

At first glance the golden branches, carefully strapped to a bundle, are reminiscent of a besom and braided objects of a different kind. The buffet displays and luminaires of the "Somnia" series are assembled from organically shaped, filigree rods which are made of solid brass in traditional sand casting. These single components, reminiscent of brittle branches, are afterwards melded in complex handicraft to impressive unique pieces. The matt-golden surface of the "Somnia" series harmonises elegantly with the grey glass of the handblown bowls, which have been specially adapted to the shape of the small stands. The two bigger buffet raisers form a precious basis for bowls and buffet platters of all kind. Optionally available black rubber caps can be fixed if required to improve the slip resistance and to protect the sensitive surface of furniture. The smallest version of these little pieces of art also impresses at a set table. An amuse-bouche, bedded on a nest of golden branches, will be treasured by the guests for a long time.

2385.02 + 4814.23



2385.01 + 4814.17



glass bowl

dark grey, round, handblown, ground edge

item	Ø in cm	height in cm	content in l
4814.17	17	5,5	approx. 0.3
4814.23	23	9,5	approx. 1.5
4814.30	30	13	approx. 3.25
4814.40	40	10	approx. 4.5



display for bowls "Somnia"

brass, golden, matt, not dishwasher-safe

item	Ø in cm	height in cm	for glass bowl
2385.01	approx. 15.5	approx. 13.5	4814.17
2385.02	approx. 23.5	approx. 22.5	4814.23



buffet display "Somnia"

brass, golden, matt, not dishwasher-safe

item	Ø in cm	height in cm
2386.10	approx. 21.5	approx. 10.5
2386.20	approx. 21.5	approx. 20.5



protecting cap

rubber, black, for buffet display "Somnia" items 2386...

item	Ø in cm	PU
4685	0,4	10 pcs



2386.10 + 4814.40 + 4685

The wind light of the "Somnia" series is equipped with a solid base plate with an elevated rim. This base avoids a leakage of wax and protects the table surface from heat. Furthermore, it forms the frame for a removable cylinder, made of heat resistant glass, which by way of its satined surface, intensifies the mood of light and protects the flame from wind at the same time. With candlelight, this extraordinary lighting object creates fascinating effects and provides for a cosy and comfortable ambience.



wind light

borosilicate glass, satined inside, open at the top and the bottom, for candle holder/wind light "Somnia" item 2383.01

item	Ø in cm	height in cm	PU
4991.02	9	14.5	6 pcs



candle holder/wind light "Somnia"

brass, golden, matt, not dishwasher-safe, for glass insert item 4991.02 (please order separately) and candles up to Ø 7 cm

item	Ø stand in cm	Ø top in cm	height in cm
2383.01	11	approx. 16.5	approx. 19.5



"Crossline"

The buffet platters "Industry 2.0" are available on page 53.



Buffet bowls in copper PVD coating are available on request.



For buffet bowl item 5704 (page 79) and platters of 42 cm x 42 cm and bigger.

Industrial charme

The variant of raw steel with a rusted and sealed surface inspires by the charm of corroded metal and perfectly matches the industrial style of modern architecture! Low weight, space-saving storage due to its stackability, easy handling and quick installation are just a few advantages of the "Crossline" series. The neutral colouring of the stands can be combined harmoniously with many different materials. Thanks to the large variety of Zieher buffet platters, the arrangement of buffets can be redesigned again and again.

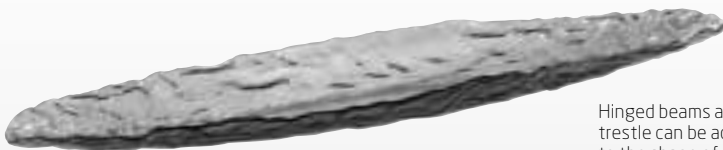

Hinged beams at the upper side of the trestle can be adjusted individually to the shape of bowls and platters.



buffet bowl

glass, 8 mm thick, dark grey, oval, structured, delivery in strong wooden box

item	l x w x h in cm
5176	130x42x8

buffet stand "Crossline" - rust

steel, rusted surface, transparent sealing, rectangular, hinged beams on top

item	l x w x h in cm	l x w in cm (on top)
8320.15R	41.5x41.5x15.5	34x34
8320.31R	49.5x49.5x31	34x34

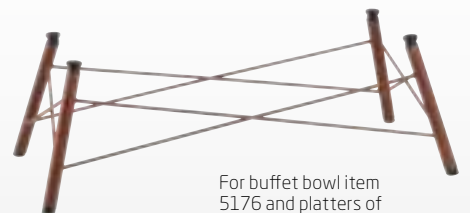

For buffet bowl item 5176 and platters of 80 cm x 40 cm and bigger.

buffet stand "Crossline" - rust

steel, rusted surface, transparent sealing, rectangular, hinged beams on top

item	l x w x h in cm	l x w in cm (on top)
8325.23R	70.5x33.5x23.5	59.5x22



More dark grey bowls are available on pages 78 to 83.



For buffet bowl item 5704 (page 79) and platters of 42 cm x 42 cm and bigger.

buffet stand "Crossline"

galvanised steel, matt black (powder coating), square, hinged beams on top

item	l x w x h in cm	l x w in cm (on top)
8320.15	41.5x41.5x15.5	34x34
8320.31	49.5x49.5x31	34x34

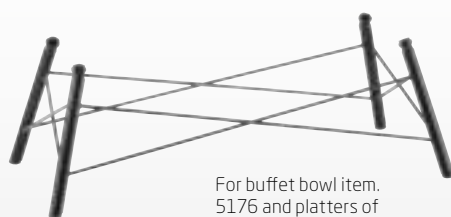

For buffet bowl item 5176 and platters of 80 cm x 40 cm and bigger.

buffet stand "Crossline"

galvanised steel, matt black (powder coating), rectangular, hinged beams on top

item	l x w x h in cm	l x w in cm (on top)
8325.23	70.5x33.5x23.5	59.5x22

Filigree understatement!

The filigree displays of the "Crossline" series feature an enormous stability due to their cleverly elaborated statics. These elements, which have been deliberately designed to have a plain and restrained appearance, unobtrusively blend into every ambience.

The rectangular base has been constructed especially for a presentation bowl made of dark grey glass, which impresses by its length of 130 cm. Hinged beams at the upper side of the trestle can be adjusted to the shape of the bowl individually. Hence also Zieher buffet platters of 80 cm x 40 cm and bigger can be installed. The supports are felt-covered, which minimises disturbing noise, evens out smaller asperities and provides for slip-resistance. Two more versions in square shape are constructed identically and are, for example, suitable for buffet platters in sizes 42 cm x 42 cm or 50 cm x 50 cm.

All trestles are made of galvanised steel and afterwards coated with a robust and scratch-proof powder-coating in a classy matt black. Therefore the stands are also suitable for outdoor areas.



The buffet bowl item 5704 is available on page 79.

“Skyline” – Manhattan-Feeling on the buffet



“Skyline”, Zieher’s buffet system, allows a maximum of flexibility for the most exclusive buffet presentations. Different heights enable you to install big buffet platters on the one hand - on the other hand, they can be stabilised by insertion into the corresponding serration. The square columns are made of highly-polished stainless steel and due to the standardised serration heights, they can be combined with the “Squareline” (pages 24 to 26) and “Curve” series (page 27).

The spectacular look that brings the silhouette of skyscrapers to mind, is available in a highly-polished version and for an intensified effect, also in black and white colouring (gold and copper on request!). The optionally available Zieher LED-lights are a perfect addition to the system and come in 2 versions: cabled and rechargeable (pages 48 and 49). In combination with light-diffusing tubes (page 48), they provide a perfect illumination of the system in various colours.



"Skyline" – the original!



The buffet platters are available on page 50.



"Skyline" – the original



Buffet platters made of glass, laminated plastic and slate are available from page 50 onwards.



buffet stand "Skyline"

massive stainless steel 18/10, matt black (powder-coated), square, not dishwasher-safe

item	l x w x h in cm
8300.10	25x25x10.5
8300.22	25x25x22.5
8300.34	25x25x34.5
8300.58	32x32x58.5

buffet stand "Skyline"

massive stainless steel 18/10, white (powder-coated), square, not dishwasher-safe

item	l x w x h in cm
8305.10	25x25x10.5
8305.22	25x25x22.5
8305.34	25x25x34.5
8305.58	32x32x58.5

buffet stand "Skyline"

massive stainless steel 18/10, highly polished, square, dishwasher-safe, food-safe

item	l x w x h in cm
2177.10	25x25x10.5
2177.22	25x25x22.5
2177.34	25x25x34.5
2177.58	32x32x58.5



silicone sleeve

transparent, slotted lengthwise, for buffet stand "Squareline" items 8081..., 8082..., 8084... and buffet stand "Skyline" items 2177..., 8300... and 8305... (prevents the slipping of buffet platters)

item	length in cm	PU
4684	2	10 pcs

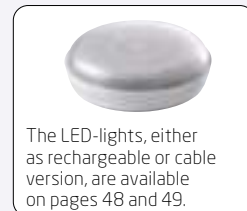

The LED-lights, either as rechargeable or cable version, are available on pages 48 and 49.



acrylic glass tube

satined (white), removable lid for easy fitting of bowls etc., notch for cable for LED-light item 8104 (not included, please order separately)

item	Ø in cm	height in cm	PU
8122.10	12	10	3 tubes
8122.22	12	22	3 tubes
8122.34	12	34	3 tubes
8122.58	12	58	3 tubes



transport trolley

aluminium / plywood with ABS-coating, slate-grey, protected against dust and splashwater, lined with rigid foam, incl. stacking cams for safe stacking. 4 heavy duty swivel castors, 2 total brakes, loadable up to 100kg

item	l x w x h (inside) in cm	l x w x h (outside) in cm
5667.01	114x74.8x60	120x80x80
5667.02	74x55x54	78x59x66



Storage and transportation trolley

We are happy to offer you an individual solution for transportation and storage of your miscellaneous items. Please ask us!



Please note:



The displays of the series "Skyline" and many other items made of stainless steel can be refined to gold and copper versions.

All information about refining of stainless steel in PVD process on page 86.



"Skyline"



Please note: The bread baskets from the "Skyline" series have a closed base plate and rubber feet. They deviate in height from the buffet stands items 2177...

The bowl "Sixth Sense" is available on page 89.

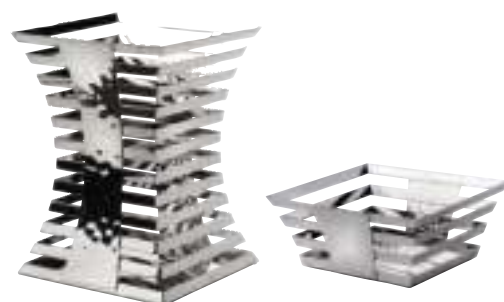

fruit/bread basket "Skyline"

massive stainless steel 18/10, highly polished, square, with bottom plate and 4 rubber feet

item	l x w x h in cm
2179.10	25x25x11.5
2179.34	25x25x35.5

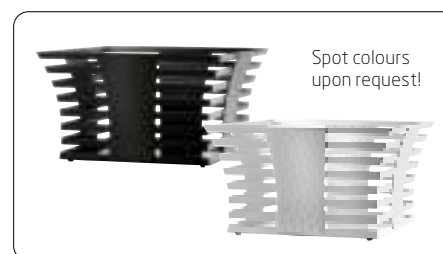

Spot colours upon request!



fruit/bread basket "Skyline"

massive stainless steel 18/10, highly polished, square, with bottom plate and 4 rubber feet

item	l x w x h in cm
2178.23	40x40x23.5

"Skyline" made by Zieher - Compare the original to copies of inferior quality!

"Skyline"

Reasons to stick with the original:

- Different versions: polished, matt black and white (golden and copper on request)
- Highest Zieher quality and perfect accuracy in manufacturing
- Compatibility with other Zieher systems
- 100 % fitting illumination
- Massive stainless steel 18/10
- Design by Zieher in 2009

Cabled and rechargeable, battery-powered
LED-lights are available on pages 48 and 49.



The "Skyline" buffet system allows a maximum of flexibility for the most exclusive buffet presentations.

Due to the same serration heights, the "Skyline" system is combinable with our "Squareline" (pages 24 to 26) and "Curve" systems (page 27). The different adaptors of the "Squareline" system may equally be used with the "Skyline" stands (exception: columns with 58 cm height).

Some exemplary displays can be seen here:



"Skyline" black, connector pieces acrylic glass satined (page 26), acrylic glass tubes (page 48), rechargeable LED-lights (page 49).

"Skyline" highly polished, connector pieces acrylic glass black (page 26), platters black glass (page 54), acrylic glass tubes (page 48), rechargeable LED-lights (page 49).

"Squareline"



"Squareline" black, acrylic connector pieces satined (page 26),
"Lightning Buffet" tubes (page 48), rechargeable LED-lights (page 49).

The rechargeable LED-light (item 8150, optionally available, page 49) offers numerous fixedly pre-installed colours, as well as special programs like colour gradient and flickering-candle-effect. The compatible remote control (item 8151) allows the synchronisation of up to 20 LED-lights at the same time and enables the change of the complete buffet-colouring by just pressing one button!

Alternatively and especially for fixed buffet installations, we recommend the use of the Zieher LED-lights with cable (item 8104, page 48).

With this item, 5 lighting colours can be set by using stick-on colour-filters.

The connector pieces feature slots, so that the cables can be laid invisibly through the columns of the "Lightning Buffet". To do this, the detachable lids of the acrylic tubes have to be removed. If cabled LED-lights are used, it is recommended to lay down all components of a "Squareline"- tower next to each other on the table to facilitate the installation of the cables.



"Squareline" black, acrylic connector pieces black (page 26),
glass platters black (page 54), glass steps black (page 58).

Please note:



To illuminate the system, you will need one LED-light and one acrylic column in the fitting size (12 resp. 24 cm) for each "Squareline" stand. The acrylic columns are available in sets of 3 pieces (items 8120...) and can be found on page 48, the information on our LED-lights can be found on pages 48 and 49.

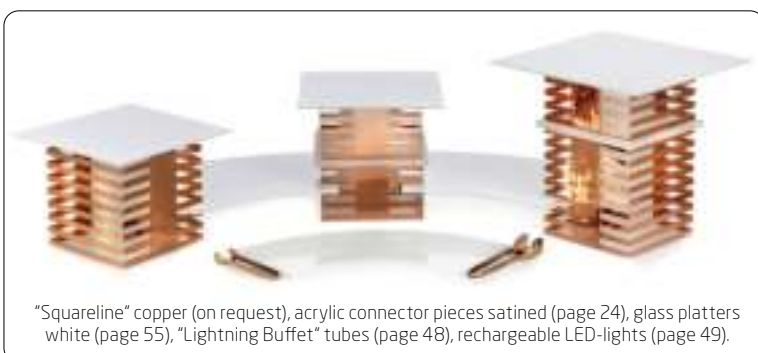

"Squareline" copper (on request), acrylic connector pieces satined (page 24), glass platters white (page 55), "Lightning Buffet" tubes (page 48), rechargeable LED-lights (page 49).



cabled LED-light,
page 48

rechargeable LED-light, page 49

acrylic tubes, item 8120..., page 48

"Squareline" white, acrylic connector pieces black (page 26), glass platters black (page 54), glass steps black and glass trays black (page 58).

"Squareline"



The buffet system with 1000 faces!

Our classic "Skyline" has been changed and advanced to become "Squareline", which now offers several new features apart from its pure design.

The stainless steel displays are available in two heights. Three versions - highly polished, matt black and white (golden and copper on request), grant the columns completely different effects! The "Squareline" towers can be stacked on top of each other by using connector pieces, which are available in two different versions. A 90° rotated arrangement of the stands increases the creative leeway tremendously and permits a buffet set-up at an angle.

Besides the technical aspect, the connector pieces are mainly a decorative element.

They are available in glossy black or satin light-diffusing acrylic. In connection with the various versions of displays and buffet platters, countless possibilities for the creation of a buffet arise.

Optionally, "Squareline" offers the possibility of a 100 % integration of our "Lightning Buffet" - the full height of the columns will be illuminated from the inside. When using the satined connector pieces, their light-diffusing effect even enhances the spectacular sight. The system is based on the buffet classic "Skyline" (pages 18 to 21), both in construction and in form. So both systems can be combined quite easily.

Just let your imagination run wild!



"Squareline" polished, acrylic connector pieces satined (page 26), platters transparent glass (page 56), buffet platter (page 56) and glass steps transparent (page 58), "Lightning Buffet" tubes (page 48), rechargeable LED-lights (page 49).

"Squareline"



silicone sleeve

transparent, slotted lengthwise, for buffet stand "Squareline" items 8081..., 8082..., 8084... and buffet stand "Skyline" items 2177..., 8300... and 8305... (prevents the slipping of buffet platters)

item	length in cm	PU
4684	2	10 pcs



acrylic connector "Squareline"

clear satin (translucent), with 4 stainless steel pins and 4 holes for cable run

item	l x w x h in cm
8083.01	27x27x3.5



acrylic connector "Squareline"

black, glossy, with 4 stainless steel pins and 4 holes for cable run

item	l x w x h in cm
8083.02	27x27x3.5



buffet stand "Squareline"

massive stainless steel 18/10, highly polished, square, dishwasher-safe, food-safe

item	l x w x h in cm
8081.13	24x24x13.5
8081.25	24x24x25.5



buffet stand "Squareline"

massive stainless steel 18/10, white (powder-coated), square, not dishwasher-safe

item	l x w x h in cm
8084.13	24x24x13.5
8084.25	24x24x25.5



buffet stand "Squareline"

massive stainless steel 18/10, matt black (powder-coated), square, not dishwasher-safe

item	l x w x h in cm
8082.13	24x24x13.5
8082.25	24x24x25.5



Flexibility with a concept

"Curve" is made of 3 mm strong, galvanised steel with a high grade powder coating.

This guarantees great stability and corrosion-resistance. The gaps between the bars were expressly chosen by the Milanese designer Itamar Harari to make the raisers completely compatible with the systems "Skyline" (pages 18 to 23) and "Squareline" (pages 24 to 26). The attractively priced "Curve" is therefore not only suitable as a starter version,

but also as an optimal extension of existing systems. During the development of "Curve", special attention was given to the mobile usage. Thus all components can be stored in an extremely space-saving way. Simple and swift to install, "Curve" is the perfect equipment for outdoor areas, events and catering.

Our complete range of buffet platters is available on pages 50 bis 58.



buffet stand "Curve"

galvanised steel, 3 mm thick, matt black (powder-coated), not dishwasher-safe

item	l x w x h in cm	PU
8310.22	27x27x22.5	2 pcs
8310.46	27x27x46.5	2 pcs

Design: Itamar Harari



The "Zieher-System"

Zieher offers innumerable possibilities to present food optically appealing and highly flexible. When developing new buffet products, it is most important for Zieher to guarantee compatibility among the individual systems.

The "Zieher-System" with its different heights of 12, 24 and 36 cm or 8, 16, and 24 cm leads to a perfect composition of different presentation levels on the buffet, thus offering more

flexibility in its arrangement. A wide range of buffet platters and trays of hardened glass, natural slate and laminated plastic in various styles is available on pages 51 to 58.

Thanks to the boundless possibilities in varying materials and designs, every buffet can easily be adapted to any accommodation. The system becomes part of the whole interior and assimilates harmonically into any ambiance.

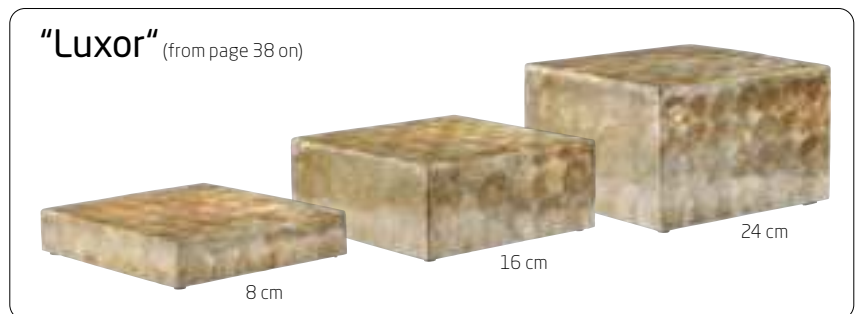
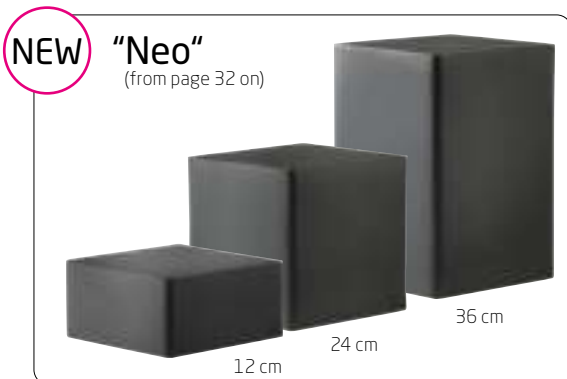
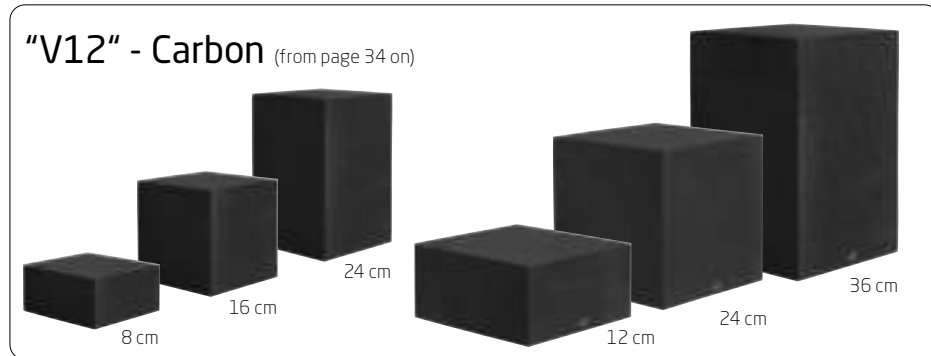
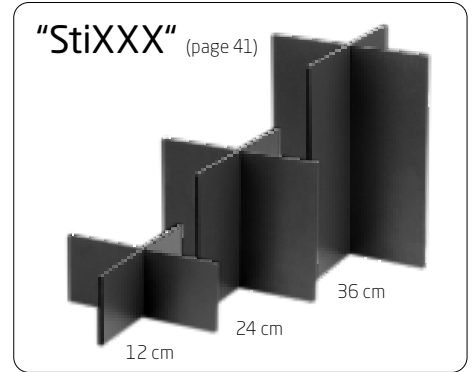
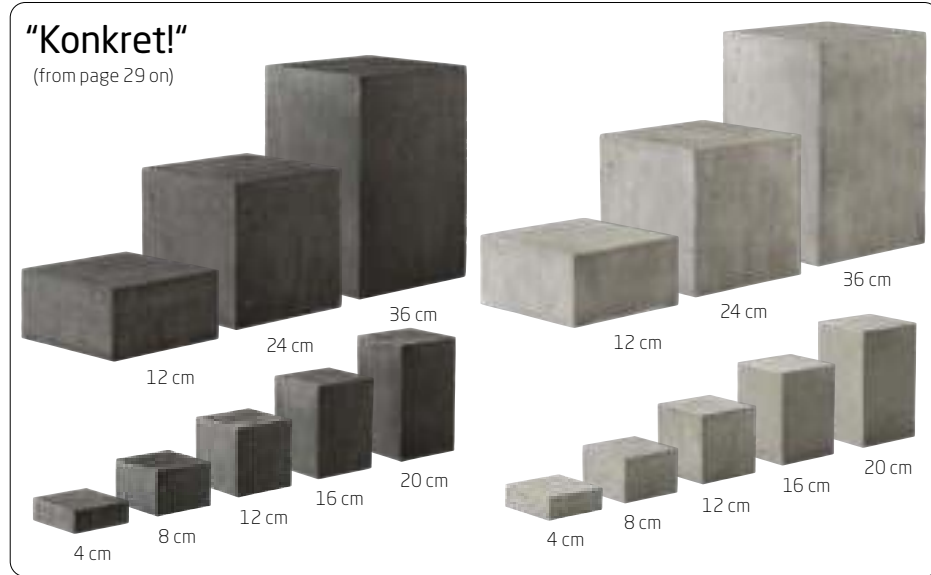



"Konkret!" - distinct design for highest flexibility!

Plain lines, neutral shapes and two different colour variations put your food presentation into focus and offer a maximum of flexibility, while at the same time, using the available space at your buffet most effectively. Maximum reduced shapes in combination with the rough look of concrete - "Konkret!" blends in particularly well with modern architecture. "Less is more" is the motto! Both variants of the displays (light grey and dark grey) are available in eight sizes, a dark grey XXL bowl impresses with huge size paired with light weight.



The XXL bowl "Konkret!" is available on page 31.



The displays consist of a mixture of fibreglass and stone and therefore offer the deceptively genuine optics of concrete combined with low weight and high stability, which greatly facilitates handling. The puristic flair of that system will be intensified by using glass platters. Those and other variations made of laminated plastic and slate are available on pages 50 to 58.

"Konkret!"



buffet display "Konkret!"

fibreglass/resin, dark grey (concrete look), not dishwasher-safe, splash-proof, hollow inside, bottom side open

item	l x w x h in cm	PU
8210.04D	12x12x4	2 pcs
8210.08D	12x12x8	2 pcs
8210.12D	12x12x12	2 pcs
8210.16D	12x12x16	2 pcs
8210.20D	12x12x20	2 pcs



buffet display "Konkret!"

fibreglass/resin, light grey (concrete look), not dishwasher-safe, splash-proof, hollow inside, bottom side open

item	l x w x h in cm	PU
8210.04L	12x12x4	2 pcs
8210.08L	12x12x8	2 pcs
8210.12L	12x12x12	2 pcs
8210.16L	12x12x16	2 pcs
8210.20L	12x12x20	2 pcs



buffet display "Konkret!"

fibreglass/resin, light grey (concrete look), not dishwasher-safe, splash-proof, hollow inside, bottom side open

item	l x w x h in cm
8200.12L	24x24x12
8200.24L	24x24x24
8200.36L	24x24x36



buffet display "Konkret!"

fibreglass/resin, dark grey (concrete look), not dishwasher-safe, splash-proof, hollow inside, bottom side open

item	l x w x h in cm
8200.12D	24x24x12
8200.24D	24x24x24
8200.36D	24x24x36

"Konkret!"

The XXL bowl in dark-grey concrete look inspires by its enormous size and the low weight. In empty state, it can easily be carried by one person. A filigree, but extremely solid stand made of powder-coated steel forms the perfect basis. A round glass plate separates ice from melting water and at the same time creates space for the Zieher rechargeable LED-light (page 49), which allows the illumination of the ice in striking colours. No matter if placed on the buffet table or on the stand - this bowl will leave a permanent impression on your guests!



XXL bowl "Konkret!"

fiberglass/resin, dark grey (concrete look), round, double-walled, not dishwasher-safe, waterproof-coated inside

item	Ø in cm	height in cm
8212.D	100	28

The separating plate is kept in position by a bearing edge integrated in the bowl.

The rechargeable LED-light item 8150 is available on page 49.



buffet platter/separating plate

hardened glass, 10 mm thick, satined, round, edge polished and deburred, separates ice and melt water

item	Ø in cm
5240.M	60



hand pump

highly elastic PVC, 2.5 mm thick, with hose, for easy drainage of melt water, professional quality, vacuum capacity: 10 l/min

item	Ø hose in cm	total length hose in cm
5662	2	250



rack for XXL bowls

steel, matt black (powder-coated), three-part for self assembly, adjustable feet for firm positioning on most surfaces, for XXL bowl "Konkret!" item 8212.D and XXL glass bowl item 5704

item	l x w x h in cm
8213	70x70x57

NEW "Neo"



Cable notch
for LED lamp 8104



buffet display "Neo"

resin, anthracite, matt finish, translucent, not dishwasher-safe, bottom side open, notch for cable on back side

item	l x w x h in cm
7002.12	24x24x12
7002.24	24x24x24
7002.36	24x24x36



buffet display/ice bucket "Neo"

Resin, anthracite, matt, translucent, not dishwasher-safe, open underside, with notch for cable on the back. Can be used on both sides!

item	l x w x h in cm
7005.16	53x32.5x16

Please note:



Isolated air inclusions in the material as well as slight colour deviations cannot be avoided due to production technology.



The buffet system “Neo” is made of anthracite coloured resin. The matt surfaces and softly rounded edges of these translucent cuboids appear unobtrusive and modern. “Neo” unfolds its true potential if the columns are effectively illuminated.

The optionally available LED-lights (pages 48 and 49), alternatively rechargeable or cabled, are the ideal completion to put “Neo” into its true light. Thanks to the battery-operated LED lights, which are waterproof to a depth of 1 metre and can be remote-controlled, even the ice in the ice containers can be illuminated from below – a truly fascinating sight. The large selection of different light colours enables spectacular effects!



"V12" – Carbon



buffet display "V12"

carbon fibre (fabric), high-gloss, black, not dishwasher-safe, splashproof, bottom side closed

item	l x w x h in cm
8206.08	20x20x8
8206.16	20x20x16
8206.24	20x20x24



buffet display "V12"

carbon fibre (fabric), high-gloss, black, not dishwasher-safe, splashproof, bottom side closed

item	l x w x h in cm
8205.12	24x24x12
8205.24	24x24x24
8205.36	24x24x36



"V12" combines modern and reduced forms with the precious material carbon. The elegant and three-dimensional look of the carbon fibre paired with maximum stability – "V12" adds high-tech to the buffet!

In connection with the huge Zieher assortment of buffet platters, "V12" provides a maximum in flexibility and best usage of buffet surfaces. Six different sizes of the "V12" displays offer a lot of possibilities for the individual composition of your buffet.

The standard heights of the carbon buffet displays of 12, 24 and 36 cm resp. 8, 16 and 24 cm permit an easy and simple combination with other Zieher systems. For an overview, please consult page 28.

The buffet stands "Basic" are available on page 42, buffet plates in many variants from pages 50 to 57.



"Classy"

The buffet displays "Classy" are made of translucent material and impress by their fascinating texture which is reminiscent of Italian marble or alabaster. The precise workmanship of the cubes as well as the silk-matt surface increase the fancy impression even more.

"Classy" is available in the Zieher system heights of 8, 16 and 24 cm and can therefore be combined in various ways. The open bottom side of the large displays allows an effective illumination by the optionally available LED-lights. With their different light colours, the LED-lights emphasise the appealing look and the interesting marbling of the material.

The small cube has no open underside and thus cannot be illuminated. The advantage of this construction lies in its high functionality. Its dimensions of 24 cm x 16 cm x 8 cm enable a positioning in 3 heights - a clever supplement to the squarish displays.

It is possible to stage "Classy" with or without lighting, strikingly eye-catching or quite discreetly. Whether unobtrusive and modern or playful and opulent - "Classy" fits perfectly into any ambience!



The baskets of the "Reef" series are available on pages 70 to 73.



Closed on all sides, cannot be illuminated



buffet display "Classy"

resin, white, alabaster look, not dishwasher-safe, closed on all sides, can be used in any position

item	l x w x h in cm
8231	24x16x8



The LED-lights are available on pages 48 and 49.



Notch for cable for LED-light item 8104



buffet display "Classy"

resin, white, translucent, alabaster look, not dishwasher-safe, bottom side open, notch for cable on back side

item	l x w x h in cm
8230.08	38x38x8
8230.16	38x38x16
8230.24	38x38x24



"Luxor"

The shimmering displays of the "Luxor" series enchant by the colour play of golden shades in variable nuances. This effect is created by high-quality shell imitations, which are arranged fan-shaped on a fibreglass base in sophisticated handcrafting. The honed and highly polished, multiple sealing with resin (Polyresin), emphasises the pattern and the pearlescent shine of the gold-coloured discs and provides the surface with a striking depth effect.

The buffet cuboids are available in heights of 8, 16 and 24 cm and are therefore compatible with many other displays of the Zieher system. The 38 cm x 38 cm large bearing surface can be used directly for presentation purposes or as a basis for buffet platters or stairs of various kinds.

"Luxor" adds a touch of extravagance to both the modern and classic ambiance, setting extraordinary accents in any environment.

Buffet bowls made of grey glass are available on pages 78 to 83.



The glass tubes of the "Flex" series are available on page 212.



buffet display "Luxor"

high-quality shell imitation, golden, washable, bottom side open, with 4 resin feet, not dishwasher-safe

item	l x w x h in cm
8221.08	38x38x8
8221.16	38x38x16
8221.24	38x38x24



"Solid"



The buffet displays of the "Solid" series are, as all the other items of this series, made of solid walnut wood. They may be used as containers for cutlery or French bread, but they are particularly suitable for the elevation of the "Modul" walnut trays (page 136) or other buffet platters.

The filigree finger joints at the corners testify to precise craftsmanship of the highest quality and guarantee perfect stability!

The displays made of solid wood are visually appealing and fit perfectly into the existing buffet systems "Solid" and "Mercato" (pages 110 to 125).

Please note the care instructions!
Not dishwasher-safe, do not immerse in water!



buffet display "Solid"

walnut, food-safe sealed, not dishwasher-safe, bottom side open, can be used as a stand or as a container

item	l x w x h in cm	PU
4767.12	12x12x12	2 pcs
4767.24	12x12x24	2 pcs



More displays and buffet systems made of walnut are available from page 110 on.

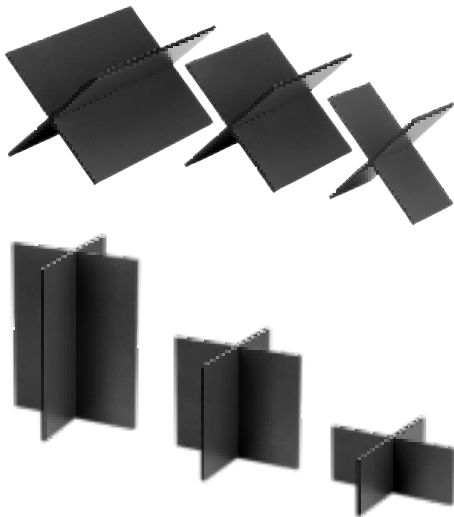

The indestructibility of laminated platters meets the advantages of plug-in systems. The plain displays are loosely stuck together, which ensures a quick and uncomplicated setup as well as a space-saving storage of the single components. Thereby "StiXXX" meets in particular the hard requirements of daily use in the catering business.

The heights of the puristic displays match perfectly with other series of the Zieher-System, by what creates numerous possible variants. Positioned as an "X" results in further presentation possibilities with a particularly slight and filigree alignment. The Zieher buffet platters and displays made of laminate are usable on both sides by the double-sided decoration. This exceedingly robust raw material is break- and scratch-proof, antistatic and dishwasher-safe and thus offers numerous advantages compared to other raw materials.

buffet display "StiXXX"

laminated plastic, 8 mm thick, dark grey, black intermediate ply, break-proof, scratch-proof, dishwasher-safe, antistatic, deburred edges, rounded corners, pluggable, 1 set (2 parts)

item	l x w x h in cm
8060.12	20x20x12
8060.24	20x20x24
8060.36	20x20x36

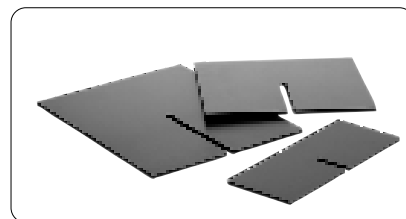

Special decor "Industry 2.0" (page 53) upon request.

The trays made of grey glass are available on page 165. Buffet platters made of laminated plastic are available on page 52/53.



"Basic"



Food: Pâtisserie Walter (www.patisserie.de)

"Basic" & "Konkret!"



buffet stand "Basic"

stainless steel 18/10 brushed (pipe \varnothing 3.2 cm), with felt pad at the top (black)

item	\varnothing in cm	height in cm	PU
8080.04	7	4	2 pcs
8080.08	7	8	2 pcs
8080.16	7	16	2 pcs
8080.24	7	24	2 pcs





The card holder made of stainless steel is available on page 106.

“Basic” is the simple and flexible solution to create different presentation levels. The high-quality columns made of matt brushed stainless steel (18/10) are a fitting base for buffet platters made of glass and other materials. The columns are fitted with felt pads on the top to protect the surface of glass platters and to level out any unevenness of the tables. The feet with 7 cm in diameter guarantee firm standing.

The unobtrusive and unadorned design of the buffet stands puts food and drinks into the limelight.

“Basic” is available in four heights and can be combined with several Zieher buffet systems (page 28). The carbon buffet stands “V12” presented here can be found on pages 34 and 35.

Please note:



We do not recommend the use of “Basic” in combination with buffet platters made of natural slate. Due to the slightly varying thickness of natural slate platters, this combination might shake.



“Basic” & “V12” Carbon

"Chiller-Base"



Cooling pillows

The cooling pads have been tailor-made for the melamine base to provide for an optimal cooling surface by the perfect fit. The pads can optionally be flipped, depending on whether the black top or the white bottom fits into the overall picture more harmoniously. So, they are applicable inconspicuously, even with slightly translucent or satined buffet platters.

The attractive contrast of top and bottom can also be used on the laid table to deliberately set accents. Serving chilled food becomes a visual highlight. The high-quality case made of black or white nylon fabric looks very noble and yet discreet. It is filled with gel, which remains malleable, even when frozen and thus allows an adaptation to a wide variety of tableware used.



cooling pack

nylon, black/white, non-toxic cooling gel

item	l x w in cm
5663.20	20x20



chiller base/tray

melamine, square, for cooling pack item 5663.20

item	colour	l x w x h in cm
459701	black	41x41x3.5
459702	white	41x41x3.5

Buffet platters made of glass in the formats 42 cm x 42 cm and 50 cm x 50 cm can be found on pages 54 to 57.



The porcelain bowl "Cave" is available on page 163.



Precise recesses on the underside facilitate positioning



The "Textura" buffet displays are available on page 12 / 13.

"Chiller-Base" - just stay cool!

The cooling elements by Zieher are an elegant and simple solution for a quick and flexible installation of chilled platters. They can be arranged either at different heights by using displays or freely positioned on the buffet table.

The flat bowls are available in matt black and white melamine and have been designed specifically for food whose presentation can be extended significantly by cooling.

The puristic form, the compact height of only 35 mm as well as the restrained colouring allow a stylishly discreet integration into numerous buffet constructions. Tailored recesses on the underside of the trays facilitate symmetrical positioning on most Zieher buffet systems. So a harmonious overall picture can be achieved quickly. Unobtrusive rubber buffers in the corners of the "Chiller-Base" ensure a non-slip and secure fit of laid-up platters in sizes starting from 42 x 42 cm (page 54 - 57).



"Skyline", page 18 - 22

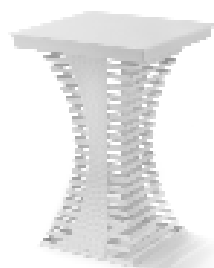

"Skyline", page 18 - 22

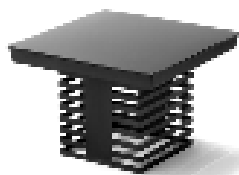

"Squareline", page 24 - 26



"Basic", page 42 / 43

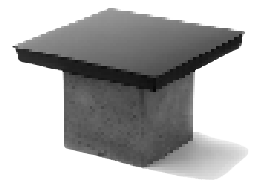

"Konkret!", page 29 / 30

"Antique"



Notch for cable for LED-light item 81.04 (page 48)



buffet stand "Antique"

polyresin sandstone mixture, sandy colour, hollow inside, notch for cable on back side

item	Ø in cm	height in cm
8011.12	12.5	12
8011.24	12.5	24
8011.36	12.5	36

Please note:



Due to the density of the material, the glow may be limited.

The decanters "Star" and "Eddy" are available on page 196 und 197.



XXL bowl glass, page 79





Bringing light into the darkness!

The illuminated buffet stands, in connection with platters made of natural slate, laminated plastic or glass (pages 50 to 57), make every buffet shine in a radiant new light. The innovative LED technology does not radiate any heat and is powered by a harmless voltage. It is characterised by its longevity and its low power consumption. The standard light of the cabled LED is white, but thanks to the coloured plastic covers, the colour scale is enlarged to contain red, yellow, green and blue (page 48).

Alternatively, there is a rechargeable LED-light with several different functions available. Besides a fixed colour range and special programs, its particular feature is a remote control that enables changing colours and programs during use. For a detailed description of this LED-light and its functions, please check out page 49.

The columns made of satined acrylic (page 48) are available in seven sizes and feature a removable cover to enable the insertion of round bowls.



"Squareline", page 24 to 26



"Stablo" page 59 to 63



LED-light with cable, item 8104...

For permanently installed buffets which are not dismantled on a daily basis, it is recommended to use the LED-light with cable item 8104.

The standard light is white; the alternative colours blue, yellow, green and red can be chosen by using the precisely fitting plastic covers items 8105... (available as accessories).

A set consists of 3 lights and the matching power supply, which can be fitted with a total of 6 lights. All cables are white and the power cable of the light has a length of 3 metres, which is enough to stow away adapter and power supply safely and invisibly under the buffet table.



Please note: The luminosity depends on the spatial realities; the actual colouring may deviate from the colours shown in the pictures!

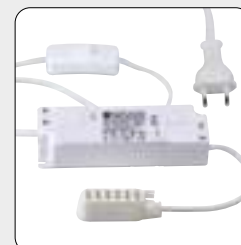

LED-light

white light, set of 3 LED-lights including power supply (cable), sixfold junction for up to 6 lights, 100-240 V, 50/60 Hz, Ø 9.7 cm, 2 cm high

item	power plug
8104	Europe
8104.UK	UK
8104.USA	USA



colour cover

plastic, for LED-light items 8104..., Ø 10 cm

item	colour	PU
8105.01	blue	3 pcs
8105.02	yellow	3 pcs
8105.03	green	3 pcs
8105.04	red	3 pcs



The height of the columns items 8122... have been adjusted especially for the illumination of the "Skyline" buffet system. The lids of all acrylic glass tubes are removable. Therefore the tubes can also function as supports for plates, bowls, etc



acrylic glass tube

satined (white), removable lid for easy fitting of bowls etc., notch for cable for LED-light item 8104 (not included, please order separately)

item	Ø in cm	height in cm	PU
8122.10	12	10	3 tubes
8122.22	12	22	3 tubes
8122.34	12	34	3 tubes
8122.58	12	58	3 tubes



acrylic glass tube

satined, white, removable lid for easy fitting of bowls etc., notch for cable for LED-light item 8104 (not included in delivery, please order separately)

item	Ø in cm	height in cm	PU
8120.01	15	12	3 tubes
8120.02	15	24	3 tubes
8120.03	15	36	3 tubes



Waterproof up to a depth of 1 metre!



The entire instruction sheet with a detailed description of all functions is available at https://www.zieher.com/fileadmin/ZieherUploads/Bedienungsanleitungen/Bedienungsanleitung_Akku_LED_Leuchte__8150_.pdf

Rechargeable LED-light with radio remote control:

The compact LED-light is controlled by remote control, which allows for a more flexible use of the Zieher "Lightning Buffet" and renders it independent from any power supply and spatial requirement.

This creates a lot of new possibilities for the buffet setup: out in the open, next to the pool or in the middle of the room - without any troublesome cables and controllers that might get into the guests' or the personnel's way. The necessary radio remote control item 8151 (to be ordered separately) rounds off the whole system in regard to function and handling and allows to choose the colouring within a range of up to 15 m without dismantling the buffet first. Due to many different colours and special programs, the buffet will fit into every kind of atmosphere. The lighting colour for the complete buffet can be changed by pressing only one button. Experience the "Lightning Buffet" - no matter where - you will be excited!



Please note: The luminosity depends on the spatial realities; the actual colouring may deviate from the colours shown in the pictures!



remote control

for rechargeable LED-light item 8150, white with grey cord

item	l x w x h in cm
8151	8.5x5.2x2.8



rechargeable LED-light

remote-controlled, 3 different degrees of brightness (only selectable on the light directly), 7 fixed colours (white, green, red, blue, yellow, violet, turquoise) and additionally: candle flickering, colour gradient and colour change (only selectable by remote control item 8151, please order separately)

item	Ø in cm	height in cm
8150	9.5	3



charging device for rechargeable LED-light

white, with handy cable spool (1.5 m of cable), wall fixing possible, 3 anti-slip rubberfeet, Ø 13 cm, 2 cm high

item	power plug
8152.EU	Europe
8152.UK	UK
8152.US	USA

- 7 fixed colours and 3 special programs, manageable via remote control (white, green, red, blue, yellow, violet, turquoise, flickering-candle-effect, colour change, colour gradient)
- 3 different brightness-settings selectable (100 % - 70 % - 50 %, only adjustable directly)
- Fixedly integrated high-performance batteries guarantee a running-time of up to 20 hrs (at the lowest brightness-setting)
- LED-light waterproof up to a depth of 1 m
- Remote control (to be ordered separately) controls up to 20 LED-lights simultaneously / range up to 15 m
- Charging device can be mounted on a wall and features a space-saving cable spool

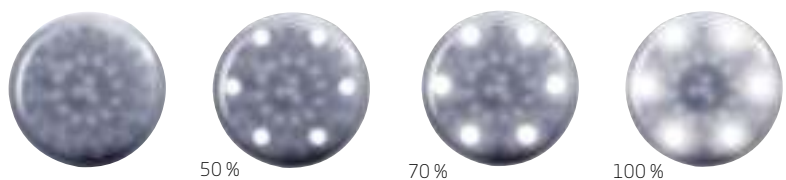

brightness-setting at the light



cable spool on charging station



recharging control light



Buffet platters and more!

Zieher is offering a wide range of buffet platters made of laminated plastic, several kinds of glass and natural slate. Due to the wide choice of formats and types of materials, there are many possibilities of combinations with Zieher's buffet systems (pages 5 to 48). The offer is being completed by various buffet stairs, trays and bowls (pages 58 to 94).



Natural slate, page 51

- Food-safe sealed/unsealed
- 10 - 15 mm thick
- With rubber feet

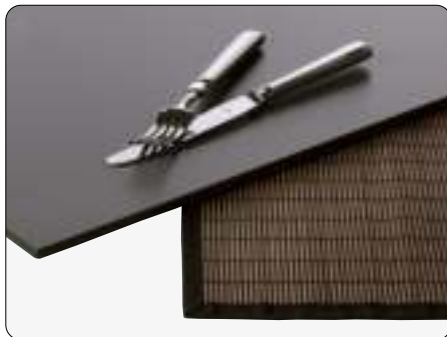

Laminated plastic, page 52

- Dark grey resp. black, black intermediate ply
- 8 mm thick
- Break-proof
- Dishwasher-safe
- Scratch-proof
- Antistatic



Laminated plastic, page 53

- Matured wood look, or rusted look, black intermediate ply
- 8 mm thick
- Break-proof
- Dishwasher-safe
- Scratch-proof
- Antistatic



Black glass, page 54

- Specially hardened safety glass
- 4 mm thick, low weight
- Edges polished and rounded
- Underside scratch-resistant, black
- Shock-proof, heat-resistant
- Dishwasher-safe



White glass, page 55

- Special hardened safety glass
- 4 mm thick, low weight
- Edges rounded and polished
- Underside scratch-resistant, white
- Shock-proof, heat-resistant
- Dishwasher-safe



Satined glass, page 56

- Specially hardened safety glass
- 10 mm thick
- Edges polished and deburred
- Underside satined
- Dishwasher-safe



Transparent glass, page 56

- Specially hardened safety glass
- 10 mm thick
- Edges polished and deburred
- Dishwasher-safe



Structured glass, page 57

- Special hardened safety glass
- 5 or 8 mm thick (depending on size)
- Edges rounded
- Underside structured
- Irregular colouring in cloudy optic
- Dishwasher-safe



Dark grey glass, page 57

- Specially hardened safety glass
- 10 mm thick, transparent
- Edges polished and deburred
- Dishwasher-safe



Buffet platters made of slate!

- Natural slate
- Food-safe sealed/unsealed
- 10 to 15 mm thick
- With rubber feet



charger plate, slate

natural slate, approx. 5 mm thick, food-safe (sealed), not dishwasher-safe, with rubber feet

item	version	l x w in cm
2543.30	square	30x30
2544.30	rectangular	30x20



buffet platter 1/1 GN, slate

natural slate, 10 to 15 mm thick, unsealed, not dishwasher-safe, rectangular, with rubber feet

item	l x w in cm
8020	53x32.5



buffet platter, slate

natural slate, 10 to 15 mm thick, food-safe (sealed), not dishwasher-safe, with rubber feet

item	version	l x w in cm
8005.01	square	50x50
8005.04	square	42x42
8005.05	rectangular	42x34
8005.06	square	34x34
8005.07	rectangular	60x40



buffet platter, slate

natural slate, 10 to 15 mm thick, food-safe (sealed), not dishwasher-safe, round, with rubber feet

item	Ø in cm
8005.21	60

Slate is a unique and exceptional natural product. The surfaces of our slate plates have the typical cleavage. Every piece is unique. Small deviations in structure, thickness (10 to 15 mm) and weight of the platters cannot be avoided, as it is in the nature of the product. Also, there could be single inclusions of other minerals and fossils. These exceptional features give slate its precious and vivid appearance. Please note: Specific groceries, especially those that contain fruit acid (citric acid) may damage the surface in case of prolonged contact. Therefore we recommend avoiding any direct contact with edibles.



Buffet platters made of laminated plastic!

- Dark grey resp. black, black intermediate ply
- 8 mm thick
- Break-proof
- Dishwasher-safe
- Scratch-proof, antistatic



The buffet crosses "StiXXX" made of laminated plastic are available on page 41.



The glass "Amuse" is available on page 215.



buffet platter, laminated plastic

laminated plastic, 8 mm thick, dark grey, black intermediate ply, break-proof, scratch-proof, dishwasher-safe, antistatic, deburred edges, rounded corners

item	version	l x w in cm
8006.01	square	50x50
8006.02	rectangular	50x42
8006.04	square	42x42
8006.06	square	34x34
8006.08	rectangular	80x21
8006.11	1/1 GN	53x32.5
8006.13	rectangular	95.4x39
8006.14	rectangular	91x21
8006.15	rectangular	102x21

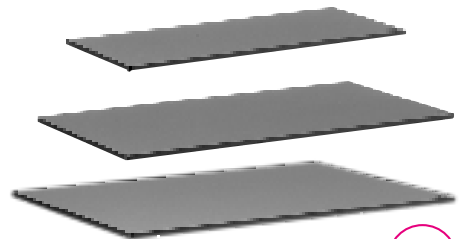

NEW

buffet platter, laminated plastic

laminated plastic, 8 mm thick, black, black intermediate ply, break-proof, scratch-proof, dishwasher-safe, antistatic, deburred edges, rounded corners

item	version	l x w in cm
8010.01	rectangular	41x17
8010.02	rectangular	49x25
8010.03	rectangular	49x33



The black buffet panels 8010... are sized to fit the LED displays „Glow“. They are available as of page 8.



Buffet platters made of laminated plastic!

- Rusted look, black intermediate ply
- 8 mm thick
- Break-proof
- Dishwasher-safe
- Scratch-proof, antistatic

The charm of transience

Break- and scratch-resistant, anti-static and dishwasher-safe – these features of laminated plastic platters and the resulting advantages are convincing!

The buffet platters made of laminated plastic are available in two neutral versions as well as in an extraordinary variation.

Unplastered brick-lined walls, load-bearing structural elements made of steel beams, exposed concrete and the morbid charms of abandoned factory buildings create the ambience for the rust-coloured decoration "Industry 2.0". This is evocative of weathered steel surfaces, which are marked by decades of corrosion and fits perfectly into the industrial style of modern architecture.

All laminated buffet platters by Zieher have a dark middle layer and can be used on both sides because of their double-coating.

Please note:



With these decors, each plate is unique – none of them look alike.



buffet platter "Industry 2.0"

laminated plastic, 8 mm thick, rusted look, black intermediate ply, break-proof, scratch-proof, dishwasher-safe, antistatic, deburred edges, rounded corners

item	version	l x w in cm
8007.01	square	50x50
8007.02	rectangular	50x42
8007.04	square	42x42
8007.06	square	34x34
8007.08	rectangular	80x21
8007.11	1/1 GN	53x32.5
8007.13	rectangular	95.4x39



All information about the displays of the "Crossline" series are available on pages 16/17.

Buffet platters made of black glass!

- Special hardened safety glass
- 4 mm thick, low weight
- Edges rounded and polished
- Underside scratch-resistant, black
- Shock-proof, heat-resistant, dishwasher-safe



The buffet system "Konkret!" is available on page 29.



buffet platter, black glass

special hardened safety glass, 4 mm thick, black, rounded edges, polished rim, dishwasher-safe, rubber feet included (adhesive), underside scratch-proof

item	version	l x w in cm
1668.01	square	50x50
1668.03	rectangular	50x34
1668.04	square	42x42
1668.05	rectangular	42x34
1668.06	square	34x34
1668.08	rectangular	80x21
1668.09	rectangular	80x40
1668.10	rectangular	30x18
1668.22	rectangular	91x21
1668.24	rectangular	102x21

NEW



buffet platter, black glass

special hardened safety glass, 4 mm thick, black, with 2 concave cutouts, rounded edges, polished rim, dishwasher-safe, rubber feet included (adhesive), underside scratch-proof

item	l x w in cm
1668.20	49x21

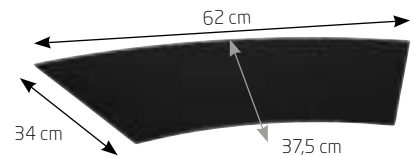

buffet platter Curve 45°

special hardened safety glass, 4 mm thick, black, curved shape, rounded edges, polished rim, dishwasher-safe, rubber feet included (adhesive), underside scratch-proof

item	l x w in cm	PU
1668.14	62x37.5	2 pcs

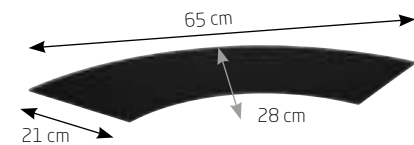

buffet platter Curve 90°

special hardened safety glass, 4 mm thick, black, curved shape, rounded edges, polished rim, dishwasher-safe, rubber feet included (adhesive), underside scratch-proof

item	l x w in cm	PU
1668.15	65x28	2 pcs



buffet platter, black glass

special hardened safety glass, 4 mm thick, black, round, edges polished, dishwasher-safe, with rubber feet (adhesive), underside scratch-proof

item	Ø in cm
1669.33	33
1669.53	53



Buffet platters made of white glass!

- Special hardened safety glass
- 4 mm thick, low weight
- Edges rounded and polished
- Underside scratch-resistant, white
- Shock-proof, heat-resistant, dishwasher-safe

buffet platter, white glass

special hardened safety glass, 4 mm thick, white, rounded edges, polished rim, dishwasher-safe, rubber feet included (adhesive), underside scratch-proof

item	version	l x w in cm
1670.01	square	50x50
1670.03	rectangular	50x34
1670.04	square	42x42
1670.06	square	34x34
1670.08	rectangular	80x21
1670.09	rectangular	80x40
1670.10	rectangular	30x18
1670.12	rectangular	66x10



buffet platter, white glass

special hardened safety glass, 4 mm thick, white, with 2 concave cutouts, rounded edges, polished rim, dishwasher-safe, rubber feet included (adhesive), underside scratch-proof

item	l x w in cm
1670.20	49x21

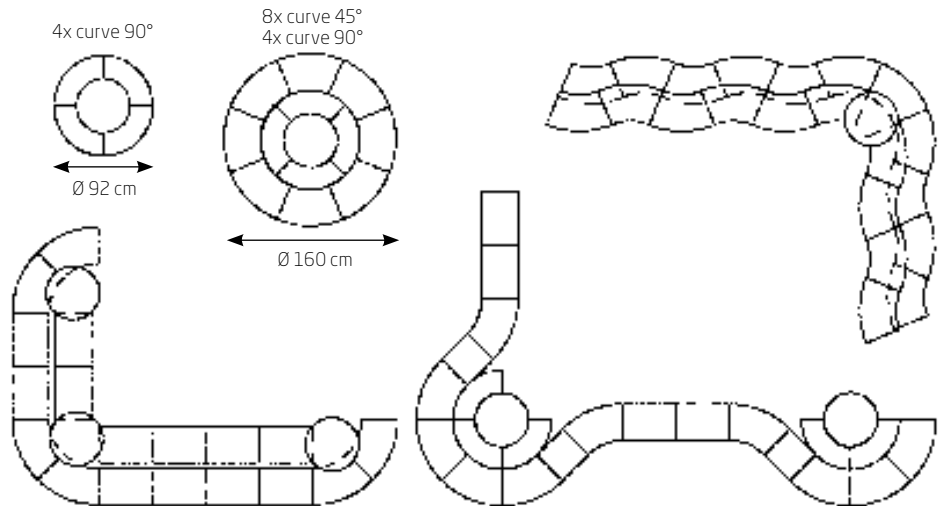
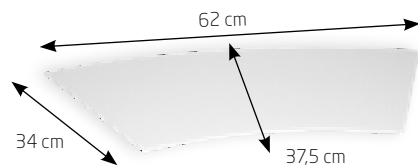

buffet platter Curve 45°

special hardened safety glass, 4 mm thick, white, curved shape, rounded edges, polished rim, dishwasher-safe, rubber feet included (adhesive), underside scratch-proof

item	l x w in cm	PU
1670.14	62x37.5	2 pcs

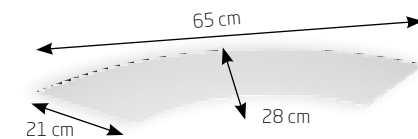

buffet platter Curve 90°

special hardened safety glass, 4 mm thick, white, curved shape, rounded edges, polished rim, dishwasher-safe, rubber feet included (adhesive), underside scratch-proof

item	l x w in cm	PU
1670.15	65x28	2 pcs



buffet platter, white glass

special hardened safety glass, 4 mm thick, white, round, edges polished, dishwasher-safe, with rubber feet (adhesive), underside scratch-proof

item	Ø in cm
1671.33	33
1671.53	53

The curved platters combined with compatible buffet platters and buffet stands allow innumerable variations! These platters are available in black glass (page 54), white glass (page 55) and transparent glass (page 56).



The buffet system "Basic" is available on page 42, the miniatures made of glass on pages 220 to 225.

Buffet platters made of satined glass!

- Special hardened safety glass
- 10 mm thick
- Edges polished and deburred
- Underside satined
- Dishwasher-safe



buffet platter, satined glass

hardened glass, 10 mm thick, satined, edges polished and deburred

item	version	l x w in cm
5243.M	rectangular	80x21



buffet platter, satined glass

hardened glass, 10 mm thick, satined, round, edges polished and deburred

item	Ø in cm
5240.M	60

Buffet platters made of transparent glass!

- Special hardened safety glass
- 10 mm thick
- Edges polished and deburred
- Dishwasher-safe

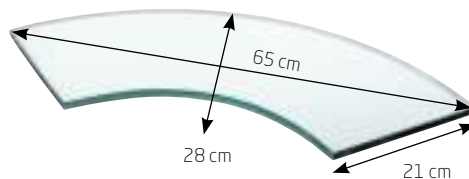

buffet platter Curve 90°

hardened clear glass, 10 mm thick, curved shape, edges polished and deburred

item	l x w in cm	PU
5241	65x28	2 pcs

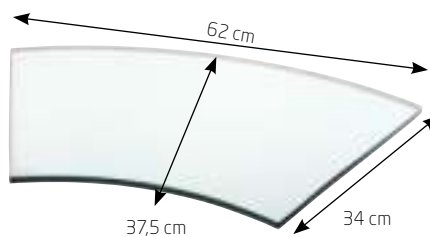

buffet platter Curve 45°

hardened clear glass, 10 mm thick, curved shape, edges polished and deburred

item	l x w in cm
5242	62x37.5



buffet platter, clear glass

hardened glass, 10 mm thick, edges polished and deburred

item	version	l x w in cm
8004.01	square	50x50
8004.02	rectangular	50x42
8004.03	rectangular	50x34
8004.04	square	42x42
8004.05	rectangular	42x34
8004.06	square	34x34
5243	rectangular	80x21
5000	rectangular	95.4x39



charger plate/glass insert

hardened clear glass, 6 mm thick, round, edge polished and deburred

item	Ø in cm
4999	33



Buffet platters made of structured glass!

- Special hardened safety glass
- 5 or 8 mm thick (depending on size)
- Edges rounded, underside structured
- Irregular colouring in cloudy optic
- Dishwasher-safe



buffet platter

hardened glass, grey transparent, irregularly coloured in a cloudy look, underside structured, dishwasher-safe, scratch-proof

item	version	l x w in cm	thickness in mm
8008.01	square	50x50	8
8008.02	rectangular	50x42	8
8008.03	rectangular	50x34	8
8008.04	square	42x42	5
8008.05	rectangular	42x34	5
8008.06	square	34x34	5
8008.07	2/1 GN	65x53	8
8008.08	rectangular	80x21	8
8008.13	rectangular	95.4x39	8

Each piece is unique!

The irregular colouring of the Zieher buffet platters is created by colour pigments, which are manually applied and fused into the glass. The colour is fixed inside the glass and therefore dishwasher-safe and abrasion resistant. Structured underside and rounded edges emphasise the effect of the platters and the individual and interesting shades of grey and intensity of colour create unique patterns in each platter!



Buffet platter made of dark grey glass!

- Special hardened safety glass
- 10 mm thick
- Edges polished and deburred
- Dark grey, transparent
- Dishwasher-safe



buffet platter, dark grey glass

hardened glass, 10 mm thick, dark grey, edges polished and deburred

item	version	l x w in cm
8004.07B	2/1 GN	65x53



The tray stand "Solid" is available on page 236.



Glass steps and more!



The buffet system "Skyline" is available on pages 18 to 23.



glass tray

glass, dark black, useable for buffet, flying buffet or as a tray

item	l x w x h in cm	version
5142.34	35x35x2	square
5141.50	51x35x2	rectangular



glass steps

5026.01: 32 cm long, 34 cm wide (horizontal position) 5026.02: 55 cm long, 42 cm wide (horizontal position)

item	l x w x h in cm (glass step)	thickness in mm
5026.01	32x34x3.5	6
5026.02	55x42x4	8



glass steps

wavy, 7 steps, delivered in a wooden box, horizontal length: 67 cm/vertical length: 65 cm

item	version	width in cm
5076.01	clear	40



glass steps

deep black 5026.03: 32 cm long, 34 cm wide (horizontal position) 5026.04: 55 cm long, 42 cm wide (horizontal position)

item	l x w x h in cm (glass step)	thickness in mm
5026.03	32x34x3.5	6
5026.04	55x42x4	8

Please note:



The glass steps items 5026... are adjusted to the Zieher system and due to their height of 12 resp. 24 cm can easily be combined with many Zieher buffet raisers (page 28).

All large steps are supplied in a sturdy wooden box!

"Stablo"



“Stablo” – filigree versatility

The buffet stands made of solid, brightly polished stainless steel impress by their high-quality workmanship and delicate appearance. Bowls and dishes appear almost hovering while slip-proof caps on the feet ensure safe support. The height of the stand (item 8016.01) is adjustable via extensions from 80 cm to 120 cm. Massive and bulky buffet tables become virtually redundant!

The buffet stand with its integrated ring (item 8016.01), allows for the presentation of plates and platters (max. dia. 21 cm on the lower level), but also for the insertion of extravagant wine coolers made of borosilicate glass. The coolers, positioned at an angle, may also be used with the “Stablo” stands in the sizes M and L.

The shape of the cooler corresponds to the already well-known Zieher glass cloches (pages 173 to 176), thicker quality borosilicate glass ensures the necessary stability! Due to its shape, any condensing water on the outside is drained off to the bottom tip. Dripping water can easily be caught by placing a small bowl on the floor or the buffet table. The integration of the optionally available Zieher rechargeable LED-lights creates breathtaking visual effects and puts champagne but also iced food in the limelight!



A three-staged buffet etagere is offering a lot of space for all kinds of food. It can be equipped with numerous trays and plates of the Zieher range. Anti-slip caps avoid annoying noise and ensure the safe grip of the trays





wine cooler

borosilicate glass, transparent, handblown, handmade, reinforced version, for "Stablo" M, L items 8015.30 and 8015.40 (by positioning the cooler at an angle) and "Stablo" XL ring item 8016.01

item	Ø in cm	height in cm
4881.26	26	approx. 43



extension "Stablo"

massive stainless steel 18/10, polished, 12 mm thick, with anti-slip rubber caps, for buffet stand "Stablo" item 8016.01 (not suitable for items 8014... and 8015...)

item	length in cm	PU
801740	40	1 set (3 parts)
801760	60	1 set (3 parts)
801780	80	1 set (3 parts)

Extension for buffet stand XL ring

801740: for a total height of 80 cm
801760: for a total height of 100 cm
801780: for a total height of 120 cm

Please note: For one buffet stand "Stablo" XL ring item 8016.01 only one set of extensions is required.



Also available separately on request



buffet stand "Stablo" XL-ring

massive stainless steel 18/10, polished, 12 mm thick, with ring-opening (Ø 12 cm inside) for wine cooler items 4881.26, with 6 anti-slip rubber caps, 3 of which are separately packed (to clip onto the bottom part while not using the extensions items 8017..., please order the extensions separately)

item	Ø upper/lower in cm	height in cm	PU
8016.01	22.5/37	40	3 pcs



By positioning the cooler at an angle it is also suitable for buffet stands "Stablo" M and L.



buffet stand "Stablo" S, M, L

massive stainless steel 18/10, polished, 10 mm thick, with 6 anti-slip rubber caps

item	Ø upper/lower in cm	height in cm	PU
8015.20	22/30	20 / S	3 pcs
8015.30	22/35	30 / M	3 pcs
8015.40	22/39	40 / L	3 pcs



buffet stand "Stablo" XS, XXS

massive stainless steel 18/10, polished, 8 mm thick, with 6 anti-slip rubber caps

item	Ø upper/lower in cm	height in cm	PU
8014.13	15/20,5	13.5/XXS	3 pcs
8014.20	15/23	20/XS	3 pcs

The rechargeable LED-light item 8150 and suitable accessories are available on page 49.



Instruction sheet with detailed description: https://www.zieher.com/fileadmin/ZieherUploads/Bedienungsanleitungen/Bedienungsanleitung_Akku_LED_8150.pdf



Positioning of ring and light



ring "SelectionA."

silicone, Ø 8.3 cm

item	colour	PU
4681.S	black	6 pcs

"Stablo"



The buffet etagere item 2193.02 in hammered look is available on page 105.

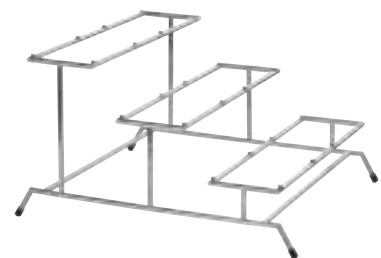

buffet etagere "Stablo"

massive stainless steel 18/10, 10 mm thick, with 4 anti-slip rubber caps and 24 rubber pads (for anti-slip placing of the trays), support for trays: 46.5 cm x 13 cm

item	l x w x h in cm
8013	46.5x54.5x30



glass tray

glass, dark grey, rectangular

item	l x w x h in cm
5161.31	31x21x3.5
5161.62	62x21x3.5



glass tray

glass, satined, rectangular

item	l x w x h in cm
5160.31	31x21x3.5
5160.62	62x21x3.5



base tray "Modul"

melamine, black, surface matt, food-safe, dishwasher-safe, not suitable for microwave and combi steam oven

item	l x w x h in cm	PU
4582	72.5x28x1.8	2 pcs



buffet platter

hardened glass, grey transparent, rectangular, irregularly coloured in a cloudy look, underside structured, dishwasher-safe, scratch-proof

item	l x w in cm	strength in mm
8008.08	80x21	8



buffet platter

special hardened safety glass, 4 mm thick, rectangular, rounded edges, polished rim, dishwasher-safe, rubber feet included (adhesive), underside scratch-proof

item	version	l x w in cm
1668.08	black glass	80x21
1670.08	white glass	80x21



buffet platter

laminated plastic, 8 mm thick, rectangular, black intermediate ply, break-proof, dishwasher-safe, antistatic, deburred edges, rounded corners

item	version	l x w in cm
8007.08	rusted look	80x21
8006.08	dark grey	80x21



tray

massive stainless steel 18/10, rectangular, hammered finish, six times polished, for buffet etagere items 2193, 2193.02 and 8013

item	l x w x h in cm
2193.01	62x18x5



buffet platter

hardened glass, 10 mm thick, rectangular, edges polished and deburred

item	version	l x w in cm
5243	transparent glass	80x21
5243.M	satined glass	80x21



base tray "Modul"

walnut, food-safe sealed, not dishwasher-safe, stackable

item	l x w x h in cm
4722	70x25,5x3,1

"Falcon"



etagere "Falcon"

massive stainless steel 18/10, highly polished, dishwasher-safe, food-safe, anti-slip silicone sleeves for use with buffet platters included

item	l x w x h in cm
8086	24x20x45



coup plate "Catering"

china, matt black, round, flat

item	Ø in cm	PU
3954.23S	23	12 pcs



plate "Rough!"

china, matt black, round, structured surface

item	Ø in cm	PU
4567.24	24	4 pcs



coup plate "Catering"

china, white, round, flat

item	Ø in cm	PU
3954.21	21	12 pcs

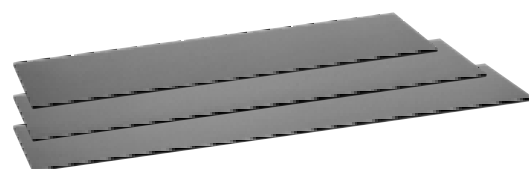

buffet platter, laminated plastic

laminated plastic, 8 mm thick, dark grey, black intermediate ply, break-proof, scratch-proof, dishwasher-safe, antistatic, deburred edges, rounded corners

item	version	l x w in cm
8006.08	rectangular	80x21
8006.14	rectangular	91x21
8006.15	rectangular	102x21

NEW



buffet platter, black glass

special hardened safety glass, 4 mm thick, black, rounded edges, polished rim, dishwasher-safe, rubber feet included (adhesive), underside scratch-proof

item	version	l x w in cm
1668.08	rectangular	80x21
1668.22	rectangular	91x21
1668.24	rectangular	102x21



More buffet platters made of laminated plastic and glass are available as of page 52.



Anti-slip sleeves provide a safe positioning of buffet platters.



"Falcon" - really detached!

This etagere, inspired by the elegance of a falcon, is giving wings to the creativity at the buffet. A single one can bear up to three plates on its wings or, when used as a duo, fitting buffet platters or a combination of both can be installed. Anti-slip supports can be plugged on if needed and thus provide a safe positioning of the platters.

As a high-tea stand, the etagere carries plain white coup plates or matt-black plates with a slate-like structure. Those plates fit exactly into the slots of the wings.

The mirror polished, solid stainless steel (3 mm) punctuates the precious impression of the dynamic shape, incorporated handrails facilitate the service. This majestic creature is sitting on a stylised branch, which also provides a firm stand.



"Shine", page 68



"Splash", page 69



"Reef", page 70 to 73



"Fakir", "Roots", "Matrix", page 74 to 75



"Capiz", page 76



"Unique", page 77



XXL Bowl, page 79



"Cave", page 82



"Duplex", page 82



"Medusa", page 87



"Art de Buffet", page 88 to 93



"Solid", page 112 to 125



Buffet bowls



Thermo bowls "Shine"



The stainless steel bowls of the "Shine" series are double-walled and therefore have an isolating effect. This helps to prevent water condensation – even at higher temperatures. Cold food stays cold and warm food stays warm longer.



The slim top edge appears elegant and filigree. The accentuated contrast between the highly polished outside and the unobtrusive finish on the inside (fine brushed stainless steel, ivory or taupe coloured) makes that series an eye-catcher. "Shine" is the perfect combination of elegance and subtlety. It is easily changeable to achieve a variation of presentations and it is effective due to its double-walled construction.



satined

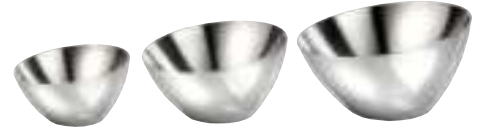

bowl "Shine"

stainless steel 18/10, outside polished, inside satined, double-walled, round/oblique, dishwasher-safe

item	Ø in cm	height in cm	content in l
2260.16	15.7	6.7/8.8	0.5
2260.20	19.7	8.5/11	0.9
2260.24	23.7	10/13	1.6



ivory



bowl "Shine"

stainless steel 18/10, outside polished, double-walled, round/oblique, food-safe coating inside (colour: ivory, not dishwasher-safe)

item	Ø in cm	height in cm	content in l
2261.16	15.7	6.7/8.8	0.5
2261.20	19.7	8.5/11	0.9
2261.24	23.7	10/13	1.6



taupe



bowl "Shine"

stainless steel 18/10, outside polished, double-walled, round/oblique, food-safe coating inside (colour: taupe, not dishwasher-safe)

item	Ø in cm	height in cm	content in l
2262.16	15.7	6.7/8.8	0.5
2262.20	19.7	8.5/11	0.9
2262.24	23.7	10/13	1.6

Please note:



When cleaning the coated bowls (ivory and taupe coloured) in the dishwasher, the coating at the rim might abrade in the course of time. Therefore it is recommended to clean these items by hand.

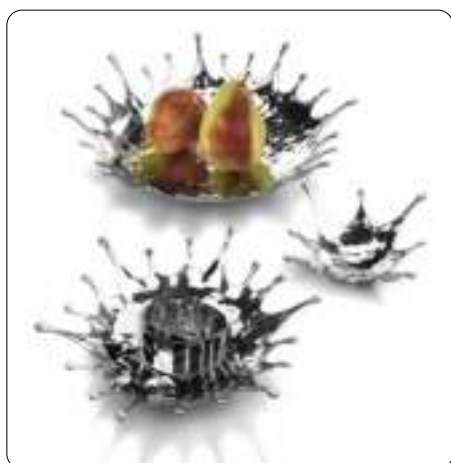

The "Splash" - effect

Dynamics of movement - solidified to a statue! The bowls of the "Splash" series spread a very special flair by their playful optics. Whether used as fruit bowl in the big, for amuse gueule, culinary delights in the small or as decorative deposit place in all varieties, "Splash" sets a charming course at the table and for interiors. The bowls are made of solid pewter, manually assembled of numerous single components and elaborately refined. Knobbed feet at the bottom side guarantee a safe stand.

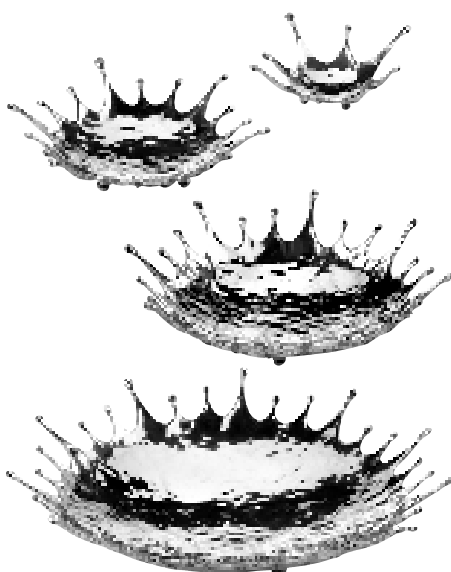

bowl "Splash"

pewter, hammered finish, polished, round, flat, food-safe, not dishwasher-safe, with supporting feet

item	Ø/height in cm	inside usable area Ø in cm
2340.15	15/5	6
2340.22	22.5/5.5	13
2340.28	28/6.5	19
2340.38	38/8	29

"Reef"

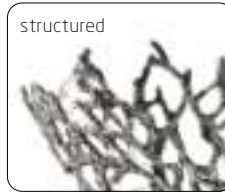

bowl/basket "Reef"

pewter, structured and patinated outside, oval, food-safe, not dishwasher-safe

item	l x w x h in cm
2332	20x10x12



bowl/basket "Reef"

pewter, structured and patinated outside, food-safe, not dishwasher-safe, with supporting feet

item	w x d x h in cm
2335	54x18x66

The projecting XXL bowl combines filigree structures with impressive dimensions. Made of premium pewter, countless fine ramifications combine to a beautifully designed whole and thus provide necessary stability with low weight at the same time.

This design gives an unobstructed view of the contents of the bowl and forms a precious frame to stage particularly fruit or other delicacies in an extravagant way. The surface of the bowl is polished on the inside, while on the outside it impresses with its coral-like structure.



bowl/basket "Reef"

pewter, structured and patinated outside, food-safe, not dishwasher-safe, with supporting feet

item	l x w x h in cm
2336	75x10x14

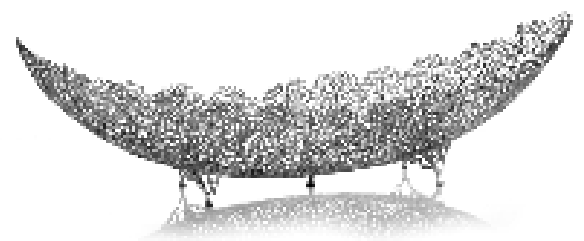

bowl/basket "Reef"

pewter, structured and patinated outside, food-safe, not dishwasher-safe, with supporting feet

item	l x w x h in cm
2337	100x24x30



bowl/basket "Reef"

pewter, surface smooth, food-safe, not dishwasher-safe, with feet

item	l x w x h in cm
2314.02	approx. 21x12.5x33
2314.03	approx. 37x18.5x52



bowl/basket "Reef"

pewter, smooth outside, oval, food-safe, not dishwasher-safe

item	l x w x h in cm
2313.01	46x19x20
2313.02	32x13x13



wind light

borosilicate glass, satined inside, open at the top and the bottom, for wind light "Reef" item 2315.01

item	Ø in cm	height in cm	PU
4991.02	9	14.5	6 pcs



candle holder/wind light "Reef"

pewter, surface smooth, food-safe, not dishwasher-safe, with feet, for glass insert item 4991.02 and candles up to Ø 7 cm

item	Ø in cm	height in cm
2315.01	10	15.5

Large numbers of single parts are casted from premium pewter and subsequently assembled in high-grade craftsmanship to give shape to these items. The inimitable pieces of art created that way are unique items, which inspire by the polished surface of the organic structures and the rounded tails of the meshwork. The products of the "Reef" series are genuine gems of dining culture! Whether there are bowls filled with bread or fruit in the focus of attention, high-quality textiles, held together by extravagant napkin rings emphasising the ambiance, or the delightful shadow play of candlelight, creating an atmospheric ambiance – "Reef" turns any table into a fine dining experience.

In the lobby or at the reception desk, which are both a hotel's hallmark, these impressive bowls guarantee lasting impressions with guests and visitors, especially when decorated with blossoms or flower bouquets.

The outside texture of the bowls differs within the series: whether smoothly rounded (page 71 to 73) or roughly structured with dark, patinated deepenings (page 70) – each variant has its own charm.



"Reef"



The glass platter is available on page 54,
the series "Flex" on page 212.



napkin ring "Reef"

pewter, real gold coated (18 ct), surface smooth, food-safe, not dishwasher-safe

item	Ø in cm	length in cm	PU
2317.G	5,5x3,5	7,5	2 pcs

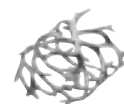

napkin ring "Reef"

pewter, surface smooth, food-safe, not dishwasher-safe

item	Ø in cm	length in cm	PU
2317	5,5x3,5	7,5	2 pcs



glass bowl

borosilicate glass, handblown, round, for bowl/basket "Reef" item 2318

item	Ø / height in cm	content in l	PU
4930	7/5	0,14	24 pcs



bowl/basket "Reef"

pewter, smooth outside, round, food-safe, not dishwasher-safe, with supporting feet, for small glass bowl item 4930 (please order separately)

item	Ø in cm	height in cm	PU
2318	8	5	2 pcs



The bowl "Splash" is available on page 69.



bowl/basket "Reef"

pewter, smooth outside, round, flat, food-safe, not dishwasher-safe

item	Ø in cm	height in cm
2311	22	5

Showpieces of table culture – “Reef”

NEW



bowl/basket “Reef”

pewter, smooth outside, round, food-safe, not dishwasher-safe, with supporting feet, for glass bowl item 4814.17 and 4814.23/30 (please order separately)

item	Ø in cm	height in cm	suitable to
2320	16	5.5	item 4814.17
2322	22	9.5	item 4814.23/30



glass bowl

dark grey, round, handblown, ground edge, suitable for bowl/basket “Reef” items 2320 and 2322

item	Ø / height in cm	content in l	suitable to
4814.17	17/5.5	0.3	item 2320
4814.23	23/9.5	1.5	item 2322
4814.30	30/13	3.25	item 2322



bowl/basket “Reef”

pewter, smooth outside, round, food-safe, not dishwasher-safe, with supporting feet, for small glass bowl item 5166 (please order separately)

item	Ø in cm	height in cm
2310	13	8



glass bowl

glass, 6 mm thick, dark grey, organically shaped, for bowl/basket “Reef” item 2310 (please order separately)

item	Ø / height in cm	content in l	PU
5166	13/6.5	approx. 0.3	2 pcs



2320 + 4814.17



2322 + 4814.23



2322 + 4814.30



smooth

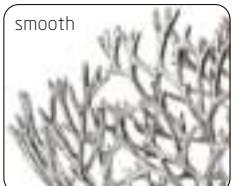

Please note:



Since medieval times, pewter has been used primarily for table top items and has been the most important raw material for a very long time. The popularity of pewter first started decreasing in the 18th and 19th century by the progressing development of glass and the increasing popularity of porcelain. Since then the usage of pewter has shifted mainly to decorative elements. Up-to-date pewter is 100 % lead-free and therefore uncritical when used for food.



"Matrix"



bowl "Matrix"

brass, top golden (transparent coating, food-safe), bottom dark patinated, hexagonal, flat, not dishwasher-safe

item	Ø in cm	height in cm
2382.38	38	7

"Roots"



bowl "Roots"

brass, golden (transparent coating, food-safe), round, not dishwasher-safe

item	Ø in cm	height in cm
2381.38	38	8



bowl/display "Fakir"

brass, inside golden (transparent coating, food-safe), outside dark patinated, not dishwasher-safe

item	Ø in cm	height in cm
2380.07	7.5	11
2380.12	12.5	10
2380.15	15	8.5
2380.18	18	9.5

"Fakir"



coaster/glass insert

clear glass, 4 mm thick, edges polished and deburred, with 4 transparent rubber feet

item	Ø in cm	PU
5244.11	11	6 pcs
5244	13	6 pcs
5244.17	16.7	1 pc
5244.21	20.7	1 pc
5244.24	24.2	1 pc
5244.28	28.2	1 pc

The silicone feet may be attached if needed.

"Roots, Matrix & Fakir" – Brass all of a piece!

Massive brass, produced in traditional sand casting, creates unique sculptural items, which enthuse especially by their contrast between matt golden surfaces and dark patination. Opposing in form and shape but still belonging together, the bowls "Roots" and "Matrix" as well as the exceptional displays of the "Fakir" series, add up to a harmonic overall composition.

The bowls "Roots", a tight web of rootlike structures, and "Matrix", strictly geometrically constructed of hexagons, could hardly be more opposing. Especially this aspect makes the combination of the two so interesting. Besides the presentation of bread and fruit on the buffet, these bowls fascinate as sculptures or decorative elements as well. An interesting add-on to the "Fakir" bowls are round glass platters of the Zieher product range. These can be laid on easily and thus generate the option to use the impressive objects on both sides.

All items are golden-coloured and partially dark patinated, further discolouration or oxidation is prevented reliably by the food-safe sealing of the golden parts.



"Fakir"



The buffet stands of the "Somnia" series are available on page 14.

Please note:



The items made of brass are suitable for cold/dry food only. Not dishwasher-safe.



"Capiz"



The rechargeable LED-light item 8150 is available on page 49.

Ivory-coloured clamshells with a nacreous gloss grant these products their special appeal. In combination with crushed ice and the Zieher rechargeable LED-lights, the double-walled bowls produced in mosaic-look create fascinating effects, thus becoming the eye-catcher at the buffet. The double-walled construction provides insulating characteristics. This prevents the formation of condensation on the outside of the bowls to the greatest possible extent.



Separates ice and melt water

charger plate, white glass

special hardened safety glass, 4 mm thick, white, edge polished, dishwasher-safe, with rubber feet (adhesive), underside scratch-proof

item	Ø in cm
1671.33	33



bowl "Capiz"

shell, ivory-coloured, double-walled, round, rim approx. 2 cm wide, resin-coated, not dishwasher-safe

item	Ø in cm	height in cm
7109.46	46	23



bowl "Capiz"

shell, ivory-coloured, oval, resin-coated, not dishwasher-safe

item	l x w x h in cm
7106.46	46.5x24x13.5



bowl "Capiz"

shell, ivory-coloured, double-walled, round, with slightly cone-shaped bottom, rim approx. 3 cm wide, resin-coated, not dishwasher-safe

item	Ø in cm	height in cm
7112.36	36	17.5

Please note:



Suitable for cold and dry food, not dishwasher-safe.

"Unique"



The etagere "DressCoat" is available on page 94, the total series "Unique" on page 164.



glass bowl "Unique"

glass, white marbled, outside satined, round

item	Ø / height in cm	content in l	PU
5182.16	16/5	approx. 0.67	6 pcs
5182.21	21/8	approx. 2.0	4 pcs
5182.27	26.5/8	approx. 2.75	4 pcs



bowl

clear glass, white, handblown, wavy, with clear rim

item	Ø in cm	height in cm
4810.01	approx. 38-40	approx. 9.5
4810.02	approx. 50-52	approx. 14

Manufactured in old tradition!



Please note:



Due to the complex production process, small air inclusions in the glass are inevitable.

Each of these high grade bowls is unique and almost completely handcrafted. At this, coloured glass is completely covered with crystal clear glass. This process awards the bowls with top brilliance and an impressive look. The handblown glass blank is modelled manually, whereby unique pieces are created which excite by their organic shape.

Platters and bowls made of grey glass



The gold-plated napkin ring "Reef" is available on page 72.



glass platter/tray

glass, structured, dark grey, rectangular, with handles

item	version	l x w x h in cm	PU
5021.01	1/1 GN	53x32.5x2	3 pcs
5021.02	1/2 GN	32.5x26.5x2	4 pcs
5021.03	2/4 GN	53x16x2	4 pcs

The buffet crosses "StiXXX" made of laminated plastic are available on page 41.



The buffet stands "Crossline" are available on page 17.



buffet bowl

glass, 8 mm thick, dark grey, oval, structured, delivery in strong wooden box

item	l x w x h in cm
5176	130x42x8

glass bowl

glass, 6 mm thick, dark grey, oval, structured

item	l x w x h in cm
5175.41	41x19.5x5.5
5175.44	44.5x25x6

XXL-bowl made of grey glass



The rechargeable LED-light item 8150 is available on page 49, further variations of the "Crossline" buffet stands are available on page 16.



buffet bowl

glass, 8 mm thick, dark grey, round, structured, delivery in strengthened carton

item	Ø in cm	height in cm
5704	82	15

This monumental bowl made of dark grey glass arches like a sculpture and melts optically with crushed ice to stage classy seafood or champagne in an opulent way.

In combination with the Zieher rechargeable LEDs, which perfectly accentuate the irregular structure of the glass, the presentation becomes even more dramatic! This effect is further intensified by the optical refraction of the ice.

This impressive bowl with a diameter of 82 cm can be placed free-standing on the floor by using the fitting rack (item 8213). But also right at the buffet table or arranged together with the stands of the "Crossline" series in different heights - these designer pieces know how to impress.



rack for XXL bowls

steel, matt black (powder-coated), three-part for self assembly, adjustable feet for firm positioning on most surfaces, for XXL bowl "Konkret!" item 8212.D and XXL glass bowl item 5704

item	l x w x h in cm
8213	70x70x57

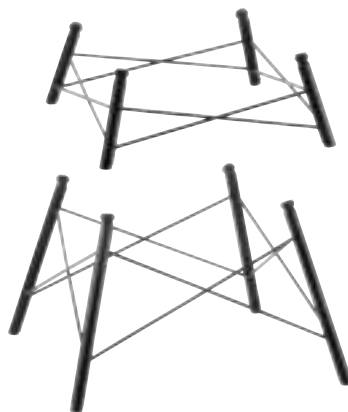

buffet stand "Crossline"

galvanised steel, matt black (powder coating), square, hinged beams on top

item	l x w x h in cm	l x w in cm (on top)
8320.15	41.5x41.5x15.5	34x34
8320.31	49.5x49.5x31	34x34





glass tray

glass, dark grey, rectangular

item	l x w x h in cm
5161.31	31x21x3.5
5161.62	62x21x3.5



glass tray

glass, satined, rectangular

item	l x w x h in cm
5160.31	31x21x3.5
5160.62	62x21x3.5



buffet bowl

glass, transparent, wide rim, structured

item	Ø in cm	height in cm
5049.35	35	6



buffet bowl

glass, transparent, wide rim, structured

item	Ø in cm	height in cm
5024.45	45	11



buffet bowl

glass, satined, concentric shape with steps

item	Ø in cm	height in cm
5013.46	46	5.5

The buffet stands are available on page 92.



glass platter

glass, structured, transparent, square

item	l x w in cm
5063	30x30
5063.50	50x50



buffet bowl

glass, satined, square

item	l x w in cm
5014.38	38x38



The buffet displays "Classy" are available on page 36 and 37.



buffet bowl

glass, 8 mm thick, dark grey, oblong, structured

item	l x w x h in cm
5703	96x29x10



glass plate

glass, 8 mm thick, dark grey, rectangular, with the structure of tree bark

item	l x w in cm	PU
5702	40x22	2 pcs



glass plate

glass, 8 mm thick, dark grey, oval, with the structure of tree bark

item	l x w in cm	PU
5700	33x24	3 pcs



glass bowl

glass, 8 mm thick, dark grey, oval, with the structure of tree bark

item	l x w x h in cm	PU
5701	26.5x19.5x4.5	3 pcs

"Cave"



The glass version of the "Cave" bowl is available in two sizes. The soft tinge of this grey glass, which is manufactured in a traditional hand-blowing process, at first glance allows an unobstructed view onto the content of these shapely objects. They offer the fitting framework for fruit, nuts and nibbles as well as for tastefully arranged pasta or salad on a solemnly decorated table. The content of the bowls remains protected by the shell of glass, the amply dimensioned opening seduces to snap at a chance. These unique items also enthuse as a place to keep all kinds of accessories. "Cave" in a smaller version, made of china, is available on page 163.



glass bowl "Cave"

dark grey, round, handblown

item	Ø in cm	opening Ø in cm	height in cm
4815.18	approx. 18	approx. 14	approx. 11.5
4815.24	approx. 24	approx. 19	approx. 16.5

"Duplex"

The solid coloured grey glass of these unique handblown pieces serves as an unobtrusive background and suitable framework for perfectly arranged dishes. The bowls can be used on both sides. A soft recess is formed when the closed side is up for ambitious dishes. By using it upside down, there will be more capacity, which is ideal e. g. to fill in crushed ice.



Useable on both sides!



The rechargeable LED-light item 8150 is available on page 49.



glass bowl "Duplex"

dark grey, round, bottom side open, useable on both sides

item	Ø in cm	height in cm
4813.28	28	6.5
4813.35	35	7.5
4813.46	46	10



We recommend the use of silicone ring 4681.S with the smallest bowl item 4814.17

Please note:



All items shown on this pages are hand-blown. Therefore it is impossible to avoid variations in glass thickness, colour intensity and weight.

The handblown bowls made of grey-tinted glass are deliberately restrained in their design, yet they have been shaped to exhibit high versatility in their appearance.

The combination of the bowls with the gold-coloured stands of the "Somnia" series (page 14) creates an opulent and extravagant buffet staging, which is fascinating purely by its appearance. The subtle grey tinting of the glass bowls also matches perfectly with the matt black surface of the optionally available silicone rings, which form a non-slip basis and increase stability.



glass bowl

dark grey, round, handblown, ground edge

item	Ø in cm	height in cm	content in l
4814.17	17	5.5	approx. 0.3
4814.23	23	9.5	approx. 1.5
4814.30	30	13	approx. 3.25
4814.40	40	10	approx. 4.5



ring "SelectionA."

silicone, Ø 8.3cm, for glass bowl item 4814.17

item	colour	PU
4681.S	black	6 pcs

The buffet stands "Somnia" are available on pages 14 und 15.



4679.S + 8150



stand/ring, illuminatable

silicone, black, Ø 15.2 cm, usable as an optional stand, for glass bowls item 4814.23 and 4814.30, suitable for rechargeable LED-light item 8150

item	Ø in cm	height in cm
4679.S	15.2	5.5



4814.23 + 4682.S



ring „SelectionA.“

silicone, Ø 13.4 cm, for glass bowls item 4814.23 and 4814.30

item	colour	PU
4682.S	black	3 pcs
4682.W	white	3 pcs

"Artisan"



Please note:



When cleaning in the dishwasher, the brass rim may change its colour in the course of time. Therefore it is recommended to clean these items by hand.



bread/pastry bowl "Artisan"

stainless steel 18/10, inside polished, outside matt finish, oval, flat, hammered rim with golden adornment (brass), bottom smooth finish

item	l x w x h in cm
2372	22x15x3.5

bread/pastry bowl "Artisan"

stainless steel 18/10, inside polished, outside matt finish, oval, high, hammered rim with golden adornment (brass), bottom smooth finish

item	l x w x h in cm
2373	22x13x7

bowl "Artisan"

stainless steel 18/10, inside polished, outside matt finish, round, hammered rim with golden adornment (brass)

item	Ø in cm	height in cm	content in l
2371.07	7.5	3.5	approx.0.1
2371.11	11	5.5	approx.0.3
2371.14	14.5	7	approx.0.7
2371.16	16.5	8	approx.1.0
2371.21	21.5	9	approx.2.0

The trays and bowls of the "Artisan" series are fascinating and diversified at the same time. The inside with its perfectly polished surface creates an interesting contrast to the matt outside.

The handcrafted rim impresses by its irregularity and is crowned by a circumferential brass edge. The combination of hammered and plain surfaces, of massive stainless steel and brass, awards this series with that certain something.

"Artisan" is a series of contrast



The plane surface of the trays facilitates the service and prevents unpleasant noise. When used at the buffet, arranged food can be presented in an appealing way and is accentuated by the reflection of the polished surfaces.



tray "Artisan"

stainless steel 18/10, inside polished, outside matt finish, oval, hammered rim with golden adornment (brass), utility space smooth finish

item	l x w in cm	height in cm
2374.24	24.5x15	approx.1.5

tray "Artisan"

stainless steel 18/10, inside polished, outside matt finish, round, hammered rim with golden adornment (brass), utility space smooth finish

item	Ø in cm	height in cm
2370.23	23	approx.2.5
2370.28	28	approx.3
2370.33	33	approx.3

etagere "Artisan"

stainless steel 18/10, inside polished, outside matt finish, round, not dishwasher-safe, hammered rim with golden adornment (brass), with brass handle, demountable, with 3 rubber feet

item	Ø in cm	height in cm
2376	33/28/23	45

Stainless steel - refined!



All information concerning refinement of glass and china are available on pages 146 and 300.



We gladly offer you buffet displays, bread baskets or cruet stands etc. with different surfaces. This option is feasible for almost all products made of stainless steel. Highly polished as well as matt stainless steel can be finished in golden, copper or black colour using the PVD process. Price, minimum order quantity and delivery time upon request.

Please ask us, we will gladly prepare an individual offer for you.



black



copper



stainless steel, polished



golden

Advantages of the PVD coating:

- Food-safe
- Dishwasher-safe
- Better strength and adherence compared to galvanic refinement
- Brilliant colouring, colourfast and resistant against UV radiation

All items made of stainless steel can be powder-coated in all current RAL colours upon request. In contrast to PVD refining, this coating is not dishwasher-safe.

We will be delighted to advise you!

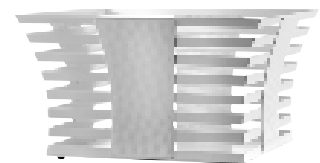



"Medusa" - risen from the deep-sea

These organically shaped bowls appear like creatures of the sea which float silently through the depth of the ocean. Even if the tentacles, modelled in numerous processing steps, appear very filigree, they still provide a safe base. Despite the solid stainless steel, these hammered bowls award a natural airiness and an almost floating impression.

"Medusa" offers the perfect setting for all sorts of seafood or extravagantly presented salads and desserts. Even as a decorative storage space, these bowls cut a good figure.

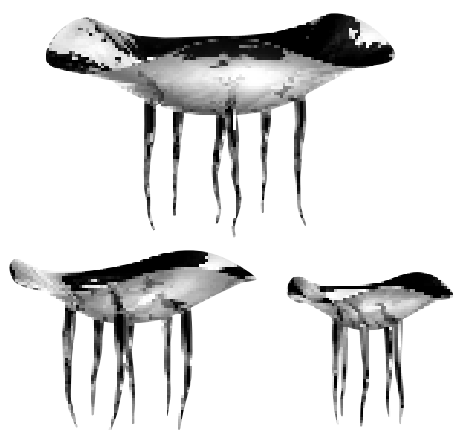

bowl "Medusa"

massive stainless steel 18/10, organically shaped, hammered finish, polished

item	l x w x h in cm
2120.15	15.5x15.5x14
2120.25	25.5x25x16.5
2120.38	38x38x23



"Art de Buffet"



bowl "Wings"

massive stainless steel 18/10, hammered finish, six times polished

item	l x w x h in cm
2169	approx. 34x22x48
2169.01	approx. 21x12.5x30.5
2169.02	approx. 15.5x9x19



etagere

massive stainless steel 18/10, round, hammered finish, six times polished, with stainless steel feet, not demountable

item	Ø in cm	height in cm
2197	50/40/30	33



The exceptional design of the "Art de Buffet" series acts as an eye-catcher at both modern and elegantly traditional buffets. It presents artistically arranged dishes in a favourable way. Every piece of this series is made of massive stainless steel 18/10, has a hand-made hammered finish and is six times hand-polished



Please note:

The baseplate has to be mounted!

bowl "Loop"

massive stainless steel 18/10, oval, hammered finish, six times polished, with black marble foot

item	l x w x h in cm
2109	approx. 39x19x67



bowl "Sixth Sense"

massive stainless steel 18/10, hammered finish, six times polished, with stainless steel feet

item	l x w x h in cm
2171	approx. 48x25x74
2171.01	approx. 37x17.5x54
2171.02	approx. 20x12x34



The XXL bowl item 2170 is available on page 93.

Buffet bowls



Feet ensure safe standing

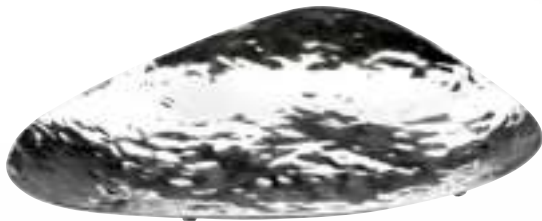

bread/pastry bowl

massive stainless steel 18/10, hammered finish, six times polished

item	l x w x h in cm
2121.22	24x15x8

bowl

massive stainless steel 18/10, round, high, hammered finish, six times polished

item	Ø in cm	height in cm	content in l
2181.14	14	7.5	1.0

bowl flat

massive stainless steel 18/10, hammered, polished

item	l x w x h in cm
2206.50	50x40x6.5
2206.60	60x46x7.5



bowl

massive stainless steel 18/10, oval, hammered finish, six times polished

item	l x w x h in cm
2183	40x23x18.5

bowl

massive stainless steel 18/10, oblong, hammered finish, six times polished

item	l x w x h in cm
2116.41	41x15.5x6.5

bowl

massive stainless steel 18/10, round, hammered finish, six times polished

item	Ø in cm	height in cm	content in l
2181.17	17	6.5	1.1
2181.21	21	8	2.0
2181.24	24	9.5	3.25



etagere

massive stainless steel 18/10, triangular, smooth finish, six times polished, not demountable

item	Ø in cm	height in cm
2187	13	16.5



bowl

massive stainless steel 18/10, triangular, smooth finish, six times polished

item	Ø in cm	height in cm	content in l
2182.09	9	4	0.08
2182.13	13	6	0.28
2182.22	22	10.5	1.25
2182.30	30	12	3.0



bowl

massive stainless steel 18/10, triangular, hammered finish, six times polished

item	Ø in cm	height in cm	content in l
2180.09	9	4	0.08
2180.13	13	6	0.28
2180.22	22	10.5	1.25
2180.30	30	12	3.0
2180.40	40	16	7.0



The glass bowls are available page 80.



buffet stand

massive stainless steel 18/10, highly polished

item	Ø in cm	height in cm
2141.01	25/20	13
2141.02	27/22	17.5
2141.03	29/25	23



2174 + 2141.01

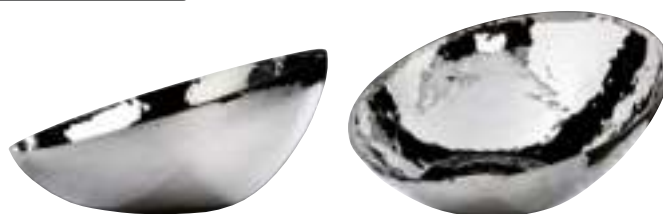

bowl

massive stainless steel 18/10, oblique, hammered finish, six times polished

item	Ø in cm	height in cm
2174	38	7/15



buffet bowl

massive stainless steel 18/10, oblong, hammered finish, six times polished

item	l x w x h in cm
2184	62x15x7



buffet bowl

massive stainless steel 18/10, square, hammered finish, six times polished, with horn-ball feet

item	l x w x h in cm
2132	31x31x17

It is recommended to clean the horn-ball feet only with moist, soft tissues and non-abrasive substances. Cleaning in the dishwasher may damage the sealing.



bowl/basin XXL

massive stainless steel 18/10, round, hammered finish, six times polished

item	Ø in cm	height in cm	content in l
2170	70	30	85.0



2170 + 5240.M
Separates ice and meltwater



"Art de Buffet"



buffet platter/separating plate

hardened glass, 10 mm thick, sated, round, reduces useable capacity of XXL bowl to approx. 40 l content (15 cm useable depth)

item	Ø in cm
5240.M	60



hand pump

highly elastic PVC, 2,5 mm thick, with hose, for easy drainage of melt water, professional quality, vacuum capacity: 10 l/min

item	Ø hose in cm	total length hose in cm
5662	2	250

The waterproof LED-light item 8150 is available on page 49.



champagner bowl

massive stainless steel 18/10, hammered finish, six times polished

item	Ø in cm	height in cm	content in l
2163	39	19	18.0



buffet bowl

glass, transparent, wide rim, structured

item	Ø in cm	height in cm
5024.45	45	11



2163 + 5024.45

Etagere "DressCoat"

Food: Pâtisserie Walter
www.patisserie.de



The etagere with three tiers, made of hammered and highly polished stainless steel, forms an extravagant basis for many sorts of plates and platters. The supporting rings with a diameter of 15 cm offer the possibility to insert not only plates and platters, but alternatively also bowls. Small black silicone rings keep inserted porcelain in position and prevent annoying clattering.

A very special aesthetic setup can be arranged by using a combination of several etageres along with the biggest plate of the "DressCoat" series (page 156). Numerous presentation areas on a total of four different levels can be created by placing additional plates directly on the table. The diameter of 22 cm is more than sufficient to put different pralines, petit fours and other creations of confectionery into the limelight in an impressive way. In connection with the almost invisible tier stands, the porcelain tablecloths appear amazingly airy and playful by their floating look-and-feel. A buffet presentation with an elegant vibrancy, caused by the drapery of the "DressCoat" plates – that's where it comes into its own.



Anti-slip-rings

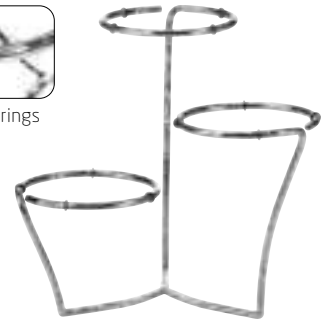

etagere "DressCoat"

massive stainless steel 18/10, hammered, polished, 3-armed

item	Ø in cm	height in cm
2212.30	36	30



plateau plate "DressCoat"

white china, useable area (plateau): Ø 19.5 cm, also useable as a bowl

item	Ø / height in cm	content in l	PU
4388	22/6.5	0.9	3 pcs



glass plate "Unique"

glass, white marbled, bottom satined, round

item	Ø in cm	PU
5178.21	21	6 pcs
5178.28	28	6 pcs

Even in the hotel room, the etageres can be positioned in an eye-catching way. Equipped with "DressCoat" or other tableware, small snacks, a selection of fruit or a sweet welcoming treat can be staged in an appealing way.



The entire series "DressCoat" is available on page 156, the series "Unique" on page 164.

Please note:

We recommend the use of large plates on the lower level only.

Etageres



"Flower-Tree"

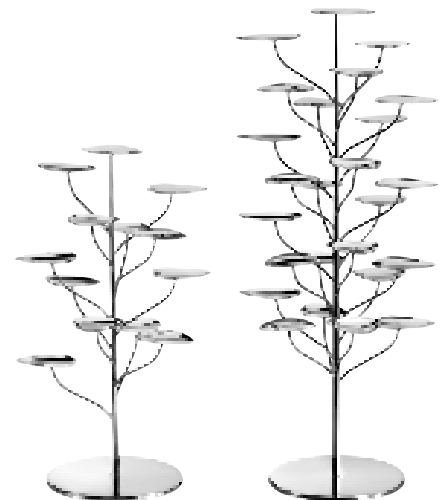

etagere "Flower-Tree"

massive stainless steel 18/10, smooth finish, polished, Ø29 cm, with miniature plates (approx. 9 cm x 7.5 cm)

item	height in cm	number of levels
2208.13	51.5	13
2208.25	71	25

"Flower-Tree" - A tree to dream of!

On 13 resp. 25 levels, these trees offer the possibility to present and showcase finger food, petit-fours and other delicacies. Also a selection of jam in handy jars can be presented in an appealing way as well as fresh apples which, placed on the leaves, invite to take one. These masterpieces of craftsmanship also accentuate the beauty of each lobby by its decorative character.

The shape of the leaves is based on the already existing plateau plates and "Flower-Tower" etageres (page 99 and 100). Especially on the buffet, this opens up the option to arrange the buffet installations diversified, but nevertheless harmoniously and variable.



The plateau plates are available on page 100.

"Flex-Tree"

The "Flex-Tree" enthralls by its versatility! On these trees, plain discs replace the fixed leaves. With a diameter of 5.5 cm, they offer sufficient space to equip the tree either with glass, porcelain or stainless steel miniatures.

To be on the safe side, they can be placed on black or white anti-slip silicone pads. This reduces the sound emission and at the same time increases the stability of the used miniatures. All trees are made of massive stainless steel and are accurately high gloss polished. The 8 mm thick foot is the perfect base and guarantees a safe stand.

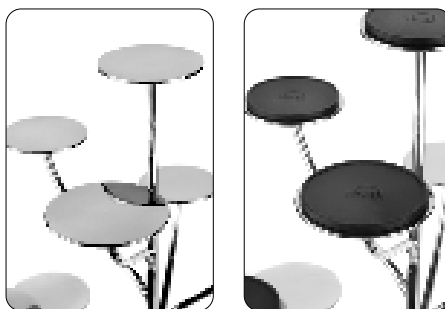

Anti-slip pads made of Silicone are available on page 214.

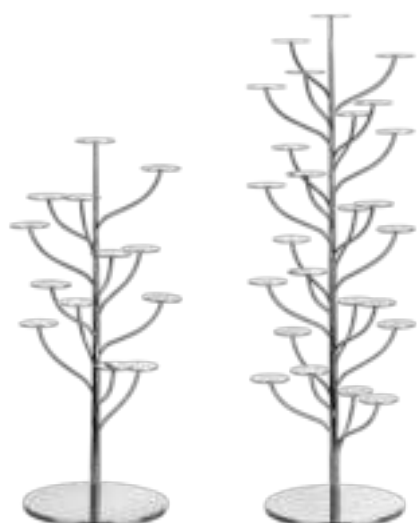

etagere "Flex-Tree"

massive stainless steel 18/10, smooth finish, polished, Ø 24 cm, with round discs (Ø 5.5 cm)

item	height	number of levels
2209.13	53	13
2209.25	72	25



plateau plate "DressCoat"

china, white, also useable as a bowl

item	Ø / height in cm	content in l	PU
4386.01	9/4.5	0.1	12 pcs

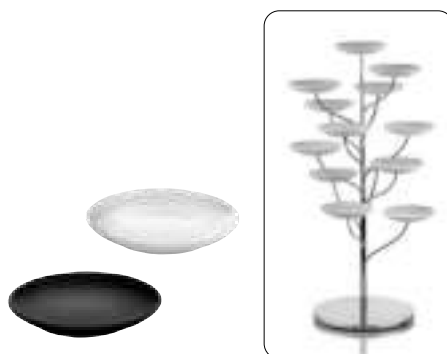

miniature plate

china, round, flat, Ø 10.5 cm

item	colour	PU
4606.10	white, glossy	12 pcs
4607.10	black, matt	12 pcs



glass miniature plate

glass, 4 mm thick, green, structured, leaf shape

item	l x w in cm	PU
5037	14x7.5	12 pcs

"Table-Tree" NEW



etagere "Table-Tree" Flower

massive stainless steel 18/10, smooth finish, polished, Ø29 cm, with miniature plates (approx. 9 cm x 7.5 cm)

item	Ø in cm	height in cm	number of levels
2208.06	29	30	6

"Table-Tree" - Tempting variety on the buffet

For the presentation of filigree delicacies in the smallest of spaces, the new "Table-Trees" from Zieher offer numerous possibilities for a stylish staging.

The trees can also be used on the buffet and are a beautiful supplement to the larger exemplars of the "Flower-Tree" and „Flex-Tree" family (pages 96/97).

A selection of fruit, chocolates or patisserie can be presented on the six organically shaped petals of the "Table-Tree" Flower. For surprising moments, the "Table-Tree" Pin offers the possibility of presenting finger food or small snacks on six skewers at different heights. Melon with ham, dates wrapped in bacon or tastefully filled parmesan baskets and edible flowers find an attractive place on the elegant branches. Each delicacy is held securely by an artfully shaped spiral and prevented from slipping.

The 30 cm high "Table-Trees" are made entirely of stainless steel by hand and polished to a high gloss.

The solid base forms the basis of these filigree products and ensures a secure stand.



The cloche (item 4852) and a suitable saucer (item 4734.03) are available on page 179.



etagere "Table-Tree" Pin

massive stainless steel 18/10, smooth finish, polished, Ø15 cm, with skewers and stoppers

item	Ø in cm	height in cm	number of levels
2210.06	15	30	6

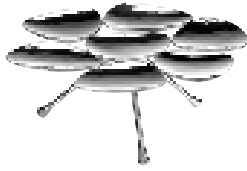

etagere with 1 tier

massive stainless steel 18/10, hammered, polished,
7 miniature plates (approx. 9 cm x 8 cm)

item	Ø in cm	height in cm
2202	25	9

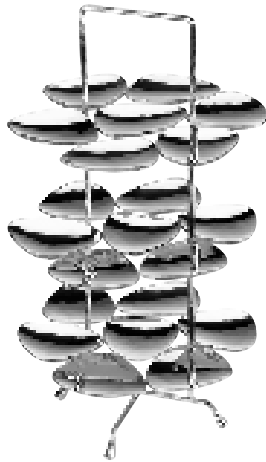

etagere with 3 tiers

massive stainless steel 18/10, hammered, polished,
21 miniature plates (approx. 9 cm x 8 cm)

item	Ø in cm	height in cm
2201	25	44.5



amuse gueule stand with foot

massive stainless steel 18/10, polished

item	l x w x h in cm
2204.08	11.5x9.5x8.5
2204.11	11.5x9.5x11.5



ice cream cup with foot

massive stainless steel 18/10, hammered, polished

item	l x w x h in cm	content in l
2207.11	11.5x10x11	0.15
2207.15	13.5x11x15	0.25



Design: Itamar Harari

Floral shapes in a steely gloss!

Seemingly organic shapes in an interplay with the gloss and reflections of hammered and polished stainless steel make up the special charm of this product line. Different etageres and plateau plates (page 100) allow a visually harmonious yet flexible and diversified presentation of appetizers or desserts on the buffet.

But also finger food, petit-fours, elaborately decorated cup cakes or a selection of chocolates in the guest room will find a convenient stage on these products. The ice cream/sorbet cups and petit-fours stands in various sizes make a nice complement and individually stage appetizers or a dessert.

The formal base for all products is a slightly arched and kidney-shaped miniature plate.

On three levels, the buffet etagere combines seven small plates each to a presentation platform of floral appearance and offers space to present up to 21 delicacies in a compact and stylish way. The single levels are supported by a filigree trestle made of massive stainless steel, which in shape and construction, deliberately readopts the design of other Zieher etageres. So nothing gets in the way of a harmonic combination of the different product lines.

The table etagere consists of one level only and is therefore perfectly suitable for the restaurant service to present intermediate courses, antipasti or dessert variations. This product is the ideal choice – even as a stylish storage dish for different types of fruit or accessories of daily use.



The massive marble platter with its 24 holes forms a stable base for various uses. Whether coil shaped holders with matching miniatures made of porcelain and glass, skewers made of high-gloss polished stainless steel or presentation platforms in different heights – the skewer platter from Zieher offers numerous options to present small delicacies in an appealing way.

More skewers and plates are available on pages 230 and 231. Please note the details of natural stone on page 231.



skewer

stainless steel 18/10, polished, 24 cm long

item	version	PU
1939.01	Moon	12 pcs
1939.02	Flame	12 pcs



miniature plate with rod

massive stainless steel 18/10, hammered, polished, plate approx. 9x8 cm, for marble platters 8052 and 8054

item	height in cm
2203.08	8
2203.13	13
2203.18	18
2203.23	23

holder coil shape

massive stainless steel 18/10, hammered finish, six times polished, for inserts made of china and glass

item	Ø in cm	total height in cm
2167.15	5.5	20
2167.20	5.5	25
2167.25	5.5	30
2167.30	5.5	35



glass miniature

clear glass

item	Ø / height in cm	content in l	PU
5405	5/8.6	0.1	6 pcs



miniature

china, stackable, Ø 5.3 cm, 7 cm high, 0.1 l content

item	colour	PU
4490	white	6 pcs
4490.01	black, matt	6 pcs



glass miniature

borosilicate glass, transparent, handblown, double-walled, with reinforced rim

item	Ø / height in cm	content in l	PU
4901.03	6/7.5	approx. 0.08	6 pcs

Please note:



Positioning of plateaus with same height is only possible to a limited extent.

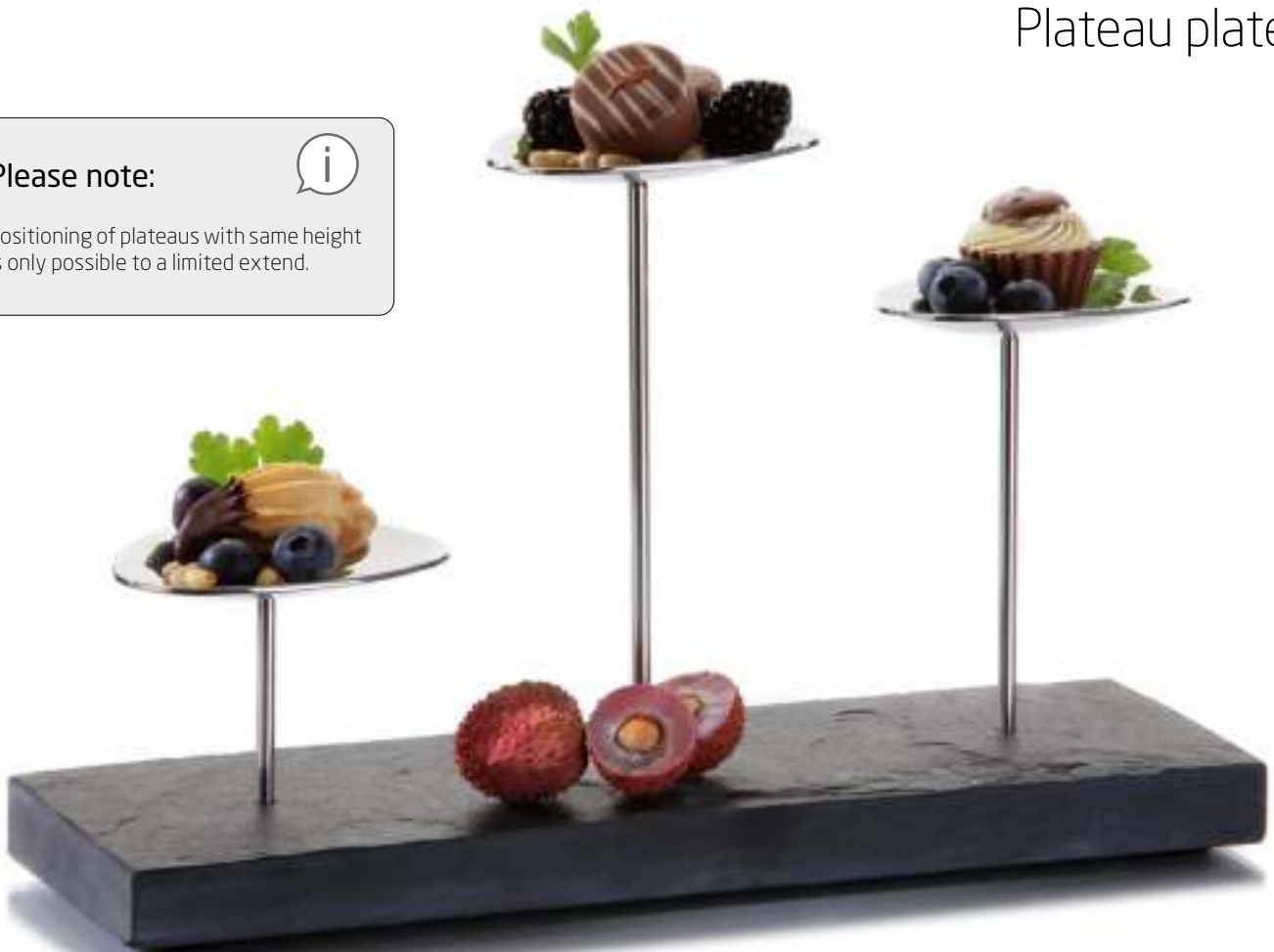

NEW

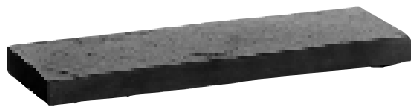

plate, slate

natural slate, rectangular, with 3 holes (Ø 5 mm), with 4 feet of felt (not dishwasher-safe), for holder coil shape items 2167... or skewer item 1939... or miniature plates items 2203... (please order separately)

item	l x w x h in cm
8054	30x10x2.5



marble platter

black/brown, polished surface, sides rough-textured, stainless steel feet, 24 holes (Ø 5 mm), for holder coil shape items 2167..., skewer items 1939... or miniature plates items 2203... (please order separately)

item	l x w x h in cm
8052	45x31x5



Design: Itamar Harari

"Art de Buffet"



More etageres for china and glass are available on the following pages.



Tilttable handle



etagere

massive stainless steel 18/10, hammered finish, six times polished, including 3 removable trays item 2110.01 (30 cm long, 8 cm wide, 3 cm high)

item	I x w x h in cm (etagere only)
2110	11.5x11.5x39 (height without handle)

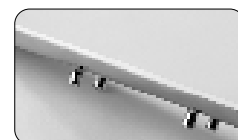

tray

massive stainless steel 18/10, rectangular, hammered finish, six times polished, with feet, for etagere item 2110

item	I x w x h in cm
2110.01	30x8x3



pastry tray

massive stainless steel 18/10, rectangular, hammered finish, six times polished

item	I x w in cm
2136	30x12.5



2107.03 + 4606.10



2107.03 + 4607.10



etagere

massive stainless steel 18/10, hammered finish, polished, with 3 insertion levels (Ø inside: 6.5 cm) for plates/bowls with max. Ø 11 cm

item	I x w x h in cm	levels
2107.03	12.5x11.5x23	3



tray

massive stainless steel 18/10, square, hammered finish, six times polished, with feet

item	l x w x h in cm
2101.17	17.5x17.5x2.3

Elegantly served and presented in style - classic plate etageres, newly inspired!

Shapely and individual stands by Zieher are suitable for numerous applications. The classic plate etageres with three levels are available in two sizes. Petit-fours, desserts, chocolates or other delicacies are effectively presented by the classic mini format etageres. The larger version is perfectly suitable for scones and jam during Five O'Clock Tea, but also a choice of cold cuts, cheese or fruit can be staged elaborately on the set table. Matching inserts made of porcelain, glass or stainless steel can be found on pages 254 and 255.



etagere

massive stainless steel 18/10, hammered finish, polished, with 3 insertion levels (Ø inside: 10.8 cm) for plates/bowls with max. Ø 17.5 cm

item	l x w x h in cm	levels
2105.03	20.5x18x37.5	3



2105.03 + 4607.17



2105.03 + 4606.17



2105.03 + 2101.17



buffet etagere

massive stainless steel 18/10, hammered finish, six times polished, including 5 trays item 2119.01 (66 cm long, 8 cm wide, 3 cm high)

item	w x d x h in cm	PU
2119	66x54x32	1 set (6 parts)



tray

massive stainless steel 18/10, rectangular, hammered finish, six times polished, with feet, for buffet etagere item 2119

item	l x w x h in cm
2119.01	66x8x3



buffet platter

special hardened safety glass, 4 mm thick, rounded edges, polished rim, dishwasher-safe, rubber feet included (adhesive), underside scratch-proof

item	version	l x w in cm
1670.12	white glass	66x10



silicone sleeve

transparent, slotted alongside, for buffet etagere item 2119, 2193 and 2193.02 (prevents the slipping of glass platters)

item	length in cm	PU
4683	1	24 pcs

For placement with glass platters, we recommend the use of non-slip silicone sleeves (item 4683).





buffet etagere

massive stainless steel 18/10, hammered finish, six times polished, including 3 trays item 2193.01 (62 cm long, 18 cm wide, 5 cm high)

item	w x d x h in cm	PU
2193	62x42x32,5	1 set (4 parts)



buffet etagere

massive stainless steel 18/10, hammered finish, six times polished, delivery without trays item 2193.01 (please order separately)

item	w x d x h in cm
2193.02	46x42x31



Glass trays are available on page 80.



tray

massive stainless steel 18/10, rectangular, hammered finish, six times polished, for buffet etagere items 2193, 2193.02 and 8013

item	l x w x h in cm
2193.01	62x18x5

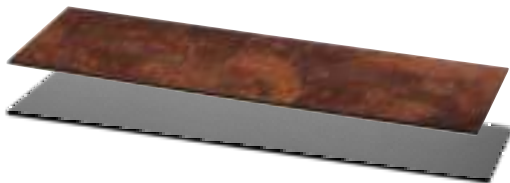

buffet platter

laminated plastic, 8 mm thick, middle layer black, break-proof, dishwasher-safe, antistatic, deburred edges, rounded corners

item	version	l x w in cm
8007.08	rusted look	80x21
8006.08	dark grey	80x21



buffet platter

tempered glass, grey transparent, irregular colouring in cloudy optics, reverse side structured, suitable for dishwashers, scratch resistant

item	l x w in cm	thickness in mm
8008.08	80x21	8



buffet platter

special hardened safety glass, 4 mm thick, rectangular, rounded edges, polished rim, dishwasher-safe, rubber feet included (adhesive), underside scratch-proof

item	version	l x w in cm
1668.08	black glass	80x21
1670.08	white glass	80x21

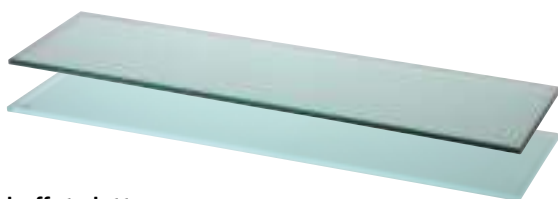

buffet platter

hardened glass, 10 mm thick, rectangular, edges polished and deburred

item	version	l x w in cm
5243	transparent glass	80x21
5243.M	satined glass	80x21



The jam trays are available on page 257.



toast rack

massive stainless steel 18/10, hammered finish, six times polished, for 4 slices of toast

item	l x w x h in cm
2190	20x8.5x15



ashtray for cigars

optical glass, transparent, also usable as a rest for tongs or spoons, in black gift box

item	l x w x h in cm
5210	15x9x3



card holder

stainless steel 18/10, polished, heavy quality, slot 1 mm wide

item	l x w x h in cm
3461	2.5x2.5x2.5



card holder

walnut, varnished, slot 2 mm wide

item	l x w x h in cm	PU
4726	8x3x3	4 pcs

table display

china, white, for self-labeling

item	l x w in cm	PU
4076	8x4.5	6 pcs



small glass bowl/spoon rest

glass, 4 mm thick, structured, dark grey, organically shaped, slightly oval form

item	l x w in cm	PU
5172	11x7.5	12 pcs



The buffet bowls are available on page 168.



tongs holder

massive stainless steel 18/10, hammered finish, six times polished, for tongs up to a length of 24 cm

item	l x w x h in cm
2115	27.5x9.5x28



spoon rest

massive stainless steel 18/10, rectangular, hammered finish, six times polished

item	l x w in cm
2154	18x10

Please note:



The tongs have a thickness of 4 mm, they rest perfectly in the hand and convey a sense of quality!



serving tongs

massive stainless steel 18/10, hammered finish, six times polished

item	length in cm
2139	28



chocolate/ice cube tongs

massive stainless steel 18/10, hammered finish, six times polished, 19 cm long

item	version
2138	stainless steel



serving tongs

massive stainless steel 18/10, hammered finish, six times polished, 21.5 cm long

item	version
2140	stainless steel

"Fingerfood-Tree"

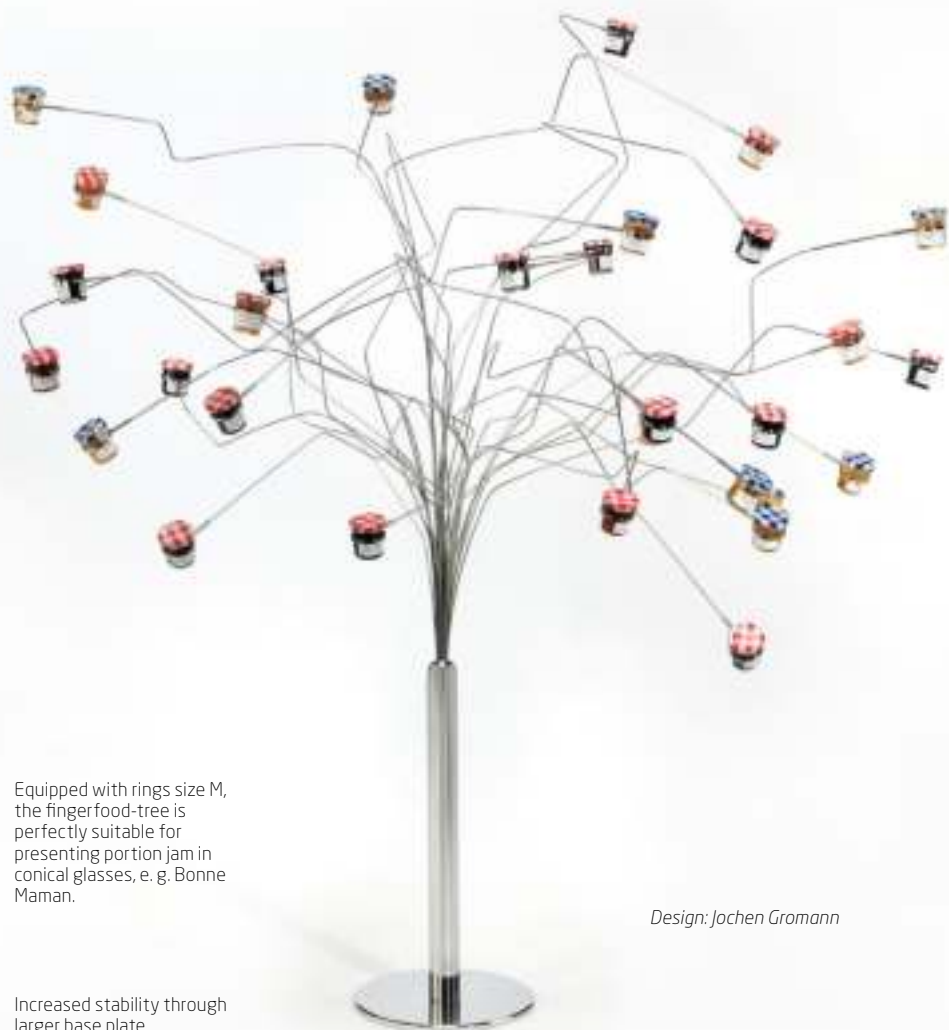

Equipped with rings size M, the fingerfood-tree is perfectly suitable for presenting portion jam in conical glasses, e.g. Bonne Maman.

Design: Jochen Gromann

Increased stability through larger base plate.

Please note:



The trees are being delivered with unbent branches; the bending has to be arranged before the first use!

The branches are made of stainless steel and will sag when loaded with food. This is why the branches should not be bent too far down when empty. In order to obtain a more favourable result, it is recommended to bend the branches one by one and to work in a circle from the outside to the inside.

The different attachments can be screwed onto the end of the branches, whereas the connection point should only be tightened up slightly. When using the rings or spiral supports, it is recommended to leave the connection point open by about half a turn, as they will turn into the apt position by themselves due to the weight of the attachments

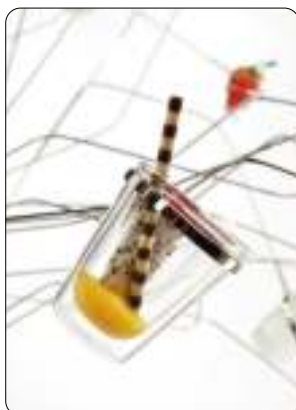

spring clip support

stainless steel 18/10, polished, to screw onto the "branches" of the fingerfood-tree item 8018.01

item	length in cm	PU
8019.01	7	10 pcs

Ring size M is suitable for portion jam in conical glasses (e.g. Bonne Maman)



ring support

stainless steel 18/10, polished, to screw onto the "branches" of the fingerfood-tree item 8018.01

item	size	Ø in cm (inside)	PU
8019.02	S	2.8	10 pcs
8019.03	M	3.8	10 pcs
8019.04	L	5.6	10 pcs

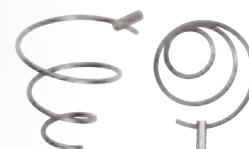

spiral support

stainless steel 18/10, polished, to screw onto the "branches" of the fingerfood-tree item 8018.01

item	Ø in cm	height in cm	PU
8019.05	4.5	4.5	10 pcs



For ring size S

glass cone

clear glass, for food display item 2194...

item	Ø / height in cm	content in l	PU
5415	3.5/8	0.03	12 pcs



For ring size L

glass miniature

borosilicate glass, transparent, handblown, double-walled, with reinforced rim

item	Ø / height in cm	content in l	PU
4901.03	6/7.5	approx. 0.08	6 pcs

"Fingerfood-Tree"



Wildly bent tree branches, supported by a base made of polished stainless steel! The fingerfood-trees by Zieher are absolutely delightful due to their extraordinary look and variable uses achieved by the different attachments!

A number of suitable attachments and applications offer a lot of possibilities and form the basis for the chef's imagination. The fingerfood-trees are perfect for patisserie creations, savory snacks in the form of mini-wraps or skewers, fruit with chocolate icing or just for jam at breakfast buffets. Furthermore, they can be placed on both buffets and bar tables with the solid base ensuring stability.

This extraordinary way of presenting fingerfood will surprise and fascinate your guests and will definitely leave a lasting impression.

The fingerfood-trees are furnished with 30 branches, which in turn can be fitted with 5 suitable attachments (page 108). Besides a clip that holds wooden skewers and a spiral for small wraps and waffles, we offer rings in three sizes, of which the medium size is especially designed for holding small conical jam jars (e.g. Bonne Maman).

Velcro straps to fasten the branches and a stout carrier bag are available from the accessory section and allow easy transport and space-saving storage of the bent trees.

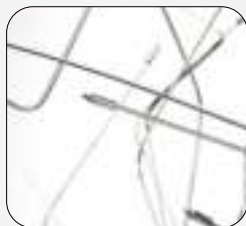

hook-and-loop strap

black, with chrome-plated clasp, for easy transport and space-saving storage of the fingerfood-tree item 8018.01

item	l x w in cm
5660	43x2.5

fingerfood tree

stainless steel 18/10, polished, 30 "branches" of equal length (87 cm) of stainless steel wire, with 6 feet of felt, height after bending of "branches": approx. 90 cm - 110 cm, threaded ends for attachment of several supports items 8019... (please order separately)

item	Ø in cm (foot)	height unbent in cm
8018.01	25	121

transport bag

polyester, black, with zip and 2 carrying straps, for fingerfood-tree item 8018.01

item	l x w x h in cm
8018.T	150x29x29

"Mercato"



The "Mercato" buffet baskets made of walnut are inspired by classic market boxes, but they are superior in many respects. Finger joints in the corners for maximum stability, solid walnut in modern design as well as deliberately chosen dimensions of the heights and lateral cutouts offer numerous advantages. "Mercato" can be converted quickly and flexibly into a buffet display by the use of buffet platters. These platters (pages 50 to 57) can simply be laid on or pushed into the lateral cutouts of the baskets (max. width 21 or 34 cm). In addition to the mere presentation of fruit or baked goods, "Mercato" is also ideal for the coffee break or for placing miniatures of any kind.



The integrated rubber feet ensure safe standing and guarantee the stackability of the baskets. Bread, rolls and pastries remain crisp and fresh longer, as the slotted bottom plates allow sufficient air circulation.

The "Solid" bed tray is a nice addition to this system. Due to its integrated foldable feet, there is no need for displays for elevated positioning. For more information on the bed tray, please see page 122, for the fitting "Solid" breakfast buffet, please check pages 116 to 121.



buffet display/basket "Mercato"

walnut, food-safe sealed, not dishwasher-safe, stackable, with 4 rubber feet (screwed on)

item	l x w x h in cm
4768.08	43x30x8
4768.12	43x30x12
4768.16	43x30x16



Integrated rubber feet guarantee stackability and safe standing.



The lateral cut-outs are suitable for buffet platters with a max. width of 21 or 34 cm.



"Solid"



Please note:

The Zieher cutting boards are oiled. The use naturally wears down their surfaces. In case of smaller abrasions, rub down the surface with a thin layer of vegetable oil or special care oil for wood kitchen countertops to refresh the surface. The above mentioned items are not dishwasher-safe. Please check the enclosed leaflet for detailed instructions.



glass cloche
borosilicate glass, transparent, handblown, handmade

item	Ø in cm	height in cm
4880.26	26	approx. 41-44



glass cloche
clear glass, handblown, with round handle

item	Ø in cm	height in cm
4852	26	43



cutting board "Solid"
walnut (end grain), oiled, stackable, not dishwasher-safe, with juice rim/groove to place cloches

item	Ø in cm	height in cm
4776	29	5



stacking ring "Solid"
walnut wood, oiled, not dishwasher-safe, with stacking rim to place cloches

item	Ø in cm	height in cm
4777	29	8.5



bowl "Solid"
walnut, oiled, not dishwasher-safe, with stacking rim to place cloches

item	Ø in cm	height in cm
4778	29	8.5



Further sizes and variations of the cloches are available on pages 114/115 and 173 to 179.



4776 + 4880.26



4776 + 4852



4778 + 4880.26

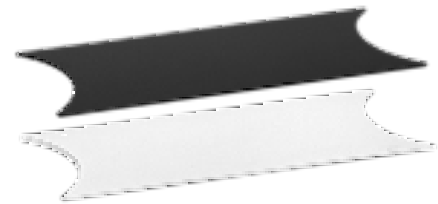

buffet platter, glass
special hardened safety glass, 49 cm long, 21 cm wide, 4 mm thick, with 2 concave cutouts, rounded edges, polished rim, dishwasher-safe, rubber feet included (adhesive), underside scratch-proof

item	colour
1668.20	black
1670.20	white



The high-quality cutting board made of fine end grain walnut wood is much more than a shapely and elegant kitchen aid. This product only unfolds its full potential in connection with the respective stacking rings and bowls. All parts have a groove at the top, which allows quick and easy stacking of the various items, even in mixed arrangement.

The milled groove of the cutting board serves on the one hand as a juice groove, on the other hand as a receptacle for various glass cloches. Thus aromatic types of cheese can be presented. A classic cloche made of handblown glass or an extravagant organically shaped cover made of highly durable borosilicate glass protects and stages the food at the same time. The stacking ring creates different levels of presentation when used in a clustered arrangement of cutting boards and trays. Also, the capacity of the bowls can be increased so as to present, for example, long baguettes.

Accurately fitting connection plates made of hardened, white or black coloured glass, can be slid exactly into the grooves of the stacked rings and thus work as buffet platters between the columns. This creates additional space and raises the flexibility of this system at the same time. Additional sizes of these plates, made of the same type of glass (page 54/55), offer a nice supplementation and allow an optically balanced buffet presentation.

The system blends in harmoniously into the walnut wood series "Solid". Using further sizes of the glass cloches allow impressive arrangements on the buffet. Cutting board, ring and bowl are sealed with high quality oils. Especially regarding the cutting board, this enables the simple refurbishment of the surface from traces of daily wear and tear.



4777 + 4778



4776 + 4777 + 4778



4777 + 4778



4776 + 4777 + 4778



4880.26 + 4776 + 4777 + 4778



Each cloche on this page is handblown and handcrafted. In contrast to our cloches made of borosilicate glass (page 115), these items are made of a single massive glass drop. As a result there can be air inclusions and minor streaks which cannot be avoided. Each cloche is individual, the result is a harmonic enlivenment of the buffet for an attractive price



glass cloche

clear glass, handblown, with round handle, for coaster "Solid" items 4734...

item	Ø in cm	height in cm
4850	18.5	31
4851	22.5	37
4852	26	43



glass cloche

clear glass, for pastry/cake stand items 5349...

item	Ø in cm	height in cm
5350.16	16	13
5350.23	23	16.5
5350.27	27.5	20.5



pastry/cake stand

clear glass, with foot

item	Ø in cm	Ø stand in cm	height in cm
5349.21	21	10.5	9.5
5349.28	28	13	11.5
5349.33	33.5	13	11

Cloches made of borosilicate glass are heat resistant, dishwasher-safe and very easy to handle for the guests. The main features of this material are a great resistance against heat and changes in temperature as well as a high breaking strength. Each item is manufactured by hand and therefore shaped individually.



glass cloche

borosilicate glass, transparent, handblown, handmade, for coaster "Solid" items 4734...

item	Ø in cm	height in cm
4880.18	18.5	approx. 29-32
4880.22	22.5	approx. 35-38
4880.26	26	approx. 41-44
4880.30	30	approx. 48-51

coaster/glass insert

clear glass, 4 mm thick, round, edge polished and deburred, with 4 transparent silicone feet

item	Ø in cm	for coaster "Solid" item
5244.17	16.7	4734.01
5244.21	20.7	4734.02
5244.24	24.2	4734.03
5244.28	28.2	4734.04

coaster "Solid"

walnut, food-safe sealed, not dishwasher-safe, stackable, for glass cloche items 4850, 4851, 4852 and 4880... and glass inserts items 5244....

item	Ø / height in cm	for cloches / inlays
4734.01	23/3	Ø 18.5/16.7 cm
4734.02	27/3	Ø 22.5/20.7 cm
4734.03	30.5/3	Ø 26/24.2 cm
4734.04	34.5/3	Ø 30/28.2 cm

More cloches made of glass are available on pages 173 to 179.

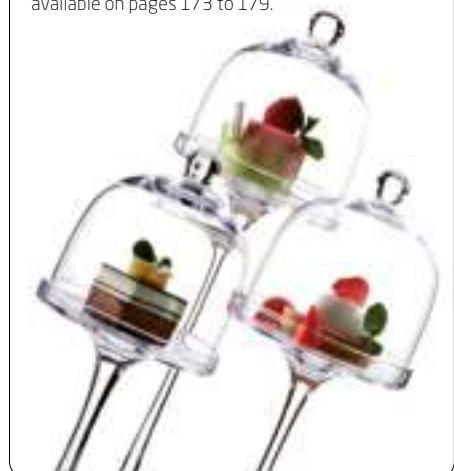

The cutting board is available on page 120.

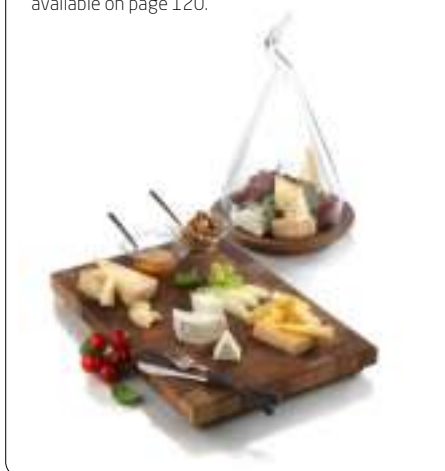

The cloches "Cuspis" are available on page 176.





The buffet displays "Solid" made of walnut are available on page 40, the trays "Modul" on page 136.



tray stand "Solid"

walnut, food-safe sealed, not dishwasher-safe, with 6 rubber feet and 16 anti-slip feet on the top side, for 2 serving trays "Solid" items 4707 and 4740

item	l x w x h in cm
4718	72.5x51x22



tray stand "Solid"

walnut, food-safe sealed, not dishwasher-safe, removable cover strip, with 6 rubber feet and 8 anti-slip feet on the top side, 2 pieces combinable with connector piece "Solid" item 4747 (for buffet setup of two pieces item 4746 one above the other), for 1 serving tray "Solid" items 4707 or 4740

item	l x w x h in cm
4746	42x51x13.5



The cutting board and the bridge "Solid" are available on pages 120 and 121.



connector piece "Solid"

walnut, food-safe sealed, not dishwasher-safe, for buffet setup of 2 pieces of the tray stand item 4746 one above the other, with 2 boreholes for wall mounting (optional, mounting material not included)

item	l x w x h in cm
4747	46.8x12x54.5



Bread and more – attractively presented!

The presentation of bread is not only important at the table, but at the breakfast buffet, too. The variety of baked goods wants to be put in the limelight.

Oblique displays for one or two wooden trays allow for a clear arrangement of various types of bread. With the help of a connector piece, two of these tray displays (item 4746) may be stacked and used on top of each other - the ideal solution for small buffet tables. A fitting cutting board including a crumb drawer and an exchangeable grate, a cutting board made of end grain wood as well as various bridges (to be found on pages 120 and 121) complete the series and provide the healthy and diversified breakfast with a new look.

Besides the flat bread tray you can also find a deeper version of this tray, which is suited especially for the presentation of rolls, buns, biscuits and pastries. A removable grate provides air circulation, freshly baked buns remain scrumptious longer. Two kinds of divisions (for the tray) offer space for several miniatures (pages 265 and 266) and allow for a flexible use of the system. A cutlery insert for the deep tray as well as an insert for slices of toasted bread round off the range.

Solid wood from the walnut tree, which is one of the most precious and most beautiful types of wood, forms the basis for this series. Both the wood's warm brown colours in different shades and its intensive and distinctive grain make every product a unique item



Suitable miniatures in sizes 5 cm x 5 cm or 7 cm x 7 cm are available on pages 265 and 266.

Please note:



Items made of walnut wood are not dishwasher-safe.



More items of the "Solid" walnut series are available on pages 234 to 245.



The miniatures made of glass and china are available on pages 265 and 266.



Glass insert
1668.03 and 1670.03
please order separately

servicing tray "Solid"

walnut, flat, food-safe sealed, not dishwasher-safe, with 2 recessed grips, with 4 rubber feet

item	l x w x h in cm	l x w (inside) in cm
4707	53x37x4	50.2x34.2



tray insert "Solid"

walnut, food-safe sealed, not dishwasher-safe, divides the tray into 8 sections (length: 31.9 cm, width: 5.4 cm each), for serving trays "Solid" items 4707 and 4740 and miniatures with a max. width / Ø of 5 cm

item	l x w x h in cm
4742	50x34x2.9



tray insert "Solid"

walnut, food-safe sealed, not dishwasher-safe, divides the tray into 6 sections (length: 31.9 cm, width: 7.5 cm each), for serving trays "Solid" items 4707 and 4740 and miniatures with a max. width / Ø of 7 cm

item	l x w x h in cm
4743	50x34x2.9



glass platter

special hardened safety glass, 4 mm thick, rectangular, rounded edges, polished rim, dishwasher-safe, rubber feet included (adhesive), underside scratch-proof, for serving tray "Solid" items 4707 and 4740

item	version	l x w in cm
1668.03	black glass	50x34
1670.03	white glass	50x34



The tray stand "Solid" is available on page 276.



4707 + 4741



4707 + 4743



4707 + 4742



4707 + 1668.03
4707 + 1670.03



servicing tray "Solid"

walnut, deep, food-safe sealed, not dishwasher-safe, 2 recessed grips, with 4 rubber feet

item	l x w x h in cm	l x w (inside) in cm
4740	53x37x10	50.2x34.2



4740 + 4745

tray insert "Solid"

walnut, food-safe sealed, not dishwasher-safe, divides the tray into 4 sections (length: 32 cm, width: 3x 13 cm and 1x 8 cm), for serving tray "Solid" item 4740

item	l x w x h in cm
4745	50x34x7



cutlery insert "Solid"

walnut, food-safe sealed, not dishwasher-safe, divides the tray into 4 sections (length: 24.9 cm, width: 11.2 cm each), for serving tray "Solid" item 4740 (for cutlery with a max. length of 24.7 cm)

item	l x w x h in cm
4744	50x27x7



grate insert "Solid"

walnut, food-safe sealed, not dishwasher-safe, with 9 rubber feet (6 mm high), for serving trays "Solid" items 4707 and 4740

item	l x w x h in cm
4741	49.8x 33.8x2



4740 + 4741



4740 + 4744



4740 + 4743



4740 + 1670.03



bread cutting board "Solid"

walnut, oiled, not dishwasher-safe, with 4 rubber feet, with walnut grate (39.8 cm long, 24.3 cm wide, 1.8 cm high, exchangeable) and 18/10 stainless steel drawer for crumbs (with magnetic fixing)

item	l x w x h in cm
4733	48x32.5x4.3

The changeable grate of the "Solid" cutting board has been constructed to protrude slightly from the cutting board to protect its rim



replacement grate "Solid"

walnut, oiled, for bread cutting board "Solid" item 4733

item	l x w x h in cm
4733.R	39.8x24.3x1.8



cutting board "Solid"

walnut (end grain), oiled, not dishwasher-safe, with 4 rubber feet (screwed on), in black gift box

item	l x w x h in cm
4732.PB	48x32.5x4.8



cutting board "Solid"

walnut (end grain), oiled, stackable, not dishwasher-safe, with juice rim/groove to place clothes

item	Ø in cm	height in cm
4776	29	5

Show cooking is a popular trend!

Whether using it for catering, at events or at the hotel's own buffet, the solid wood cutting boards by Zieher are pleasing eyecatchers and offer high functionality. The matching bridges can be equipped with bowls, putting everything tidily within reach for the work behind the buffet.

The dimensions of both cutting boards and bridges have been chosen in such a way, that exactly two boards and two bridges would fit into a regular transportation box. This is extremely useful when it comes to storing the items for their daily use and transportation for catering purposes.

"Solid" is entirely made of walnut, probably one of the most beautiful and most stylish woods.

More items from this series can be found on pages 234 to 245.



Please note:



The Zieher cutting boards are oiled. The use naturally wears down their surfaces. In case of smaller abrasions, rub down the surface with a thin layer of vegetable oil or special care oil for wooden kitchen countertops to refresh the surface. The removable grate for the bread cutting board (item 4733) can be ordered separately as a spare part (item 4733.R). The above mentioned items are not dishwasher-safe. Please check the enclosed leaflet for detailed care instructions.

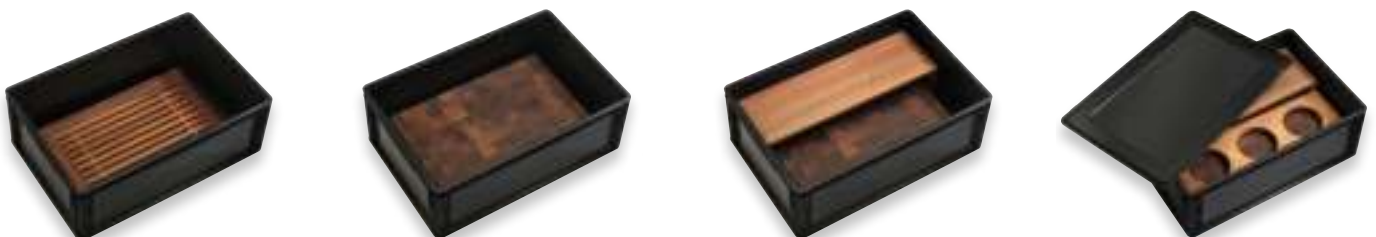

Stackable in all usual transport boxes with a size of 60 cm x 40 cm (e. g. meat box, height approx. 20 cm)



bridge "Solid"

walnut, food-safe sealed, not dishwasher-safe, with 4 rubber feet

item	l x w x h in cm
4730	54x17x16



bridge "Solid"

walnut, food-safe sealed, not dishwasher-safe, with 3 tapered holes (Ø 12 cm top side/11 cm underside), with 4 rubber feet, for bowls with max. Ø 15 cm

item	l x w x h in cm
4731	54x17x12



bowl "Shine"

stainless steel 18/10, outside polished, double-walled, round/oblique, Ø 15.7 cm, 6.7 / 8.8 cm high, 0.5 l content, for bridge "Solid" item 4731

item	colour inside
2260.16	satined (dishwasher-safe)
2261.16	ivory (not dishwasher-safe)
2262.16	taupe (not dishwasher-safe)



bowl "Catering de Luxe"

china, white, for bridge "Solid" item 4731

item	Ø / height in cm	content in l	PU
4281	14/75	0.35	6 pcs



"Solid"



bed tray "Solid"

walnut, food-safe sealed, not dishwasher-safe, stackable, with feet, 2 handles, recessed on one side of the rim

item	l x w x h in cm (closed)	l x w x h in cm (set up)
4773	60x40x6.5	74x40x31

The room service tray as well as the bed tray with feet stand out due to the precious walnut wood, which is incorporated into these products with high-quality craftsmanship. The recessed longside enables comfortable dining directly off the tray. The retractable feet of the bed tray have been constructed in a very stable way and are securely kept in position by integrated magnets when folded in. The tray also cuts a good figure on the buffet. The positioning feet make it possible to dispense with the use of displays for heightened placing. A speedy setup and flexible handling facilitate daily operations.



The rubber feet are set back from the rim to enable the transport in a tray trolley in 1/1 EN-format (60 cm x 40 cm).



The tray stand for the roomservice tray item 4735 is available on page 276.



The serving tray and suitable glass inserts are available on page 280, more "Solid" items on pages 234 to 245.



room service tray "Solid"

walnut, food-safe sealed, not dishwasher-safe, stackable, recessed on one side of the rim, with 2 handles, with 4 rubber feet, suitable for tray stand "Solid" item 4748

item	l x w x h in cm
4735	60x40x5.4



serving tray "Solid"

walnut, food-safe sealed, not dishwasher-safe, with 4 rubber feet

item	l x w x h in cm	l x w in cm (inside)
4713	34x34x3	32x32



serving tray "Solid"

walnut, food-safe sealed, not dishwasher-safe, stackable, 2 compartments: 30 cm x 30 cm and 30 cm x 8 cm (for cutlery or china/glass bowls), with 4 rubber feet

item	l x w x h in cm
4769	41.7x32.5x6.7

All information about the serving tray "Solid" item 4769 is available on page 280.

“Solid”



serving tray “Solid”

walnut, oiled, not dishwasher-safe, with changeable insert made of black coloured ceramic

item	l x w in cm
4780.46	46.5x23
4780.67	67.5x33



insert/platter

coloured ceramic, 6 mm thick, black, dishwasher-safe

item	l x w in cm
4780.46S	39x19.5
4780.67S	59x29



All information about the trays and suitable inserts are available on page 234.



The cutting boards are pluggable and can be connected with each other.



cutting/snack board “Connect!”

walnut, oiled, not dishwasher-safe, pluggable, with handle, with 4 rubber feet

item	l x w x h in cm	length incl. handle
4775.44PB	40x16x2.3	44.5



cutting/snack board “Connect!”

walnut, oiled, not dishwasher-safe, pluggable, with handle, with 4 rubber feet

item	l x w x h in cm	length incl. handle
4774.31PB		31



“Connect!”

Please note:



Please note the care instructions: not dishwasher-safe, do not immerse in water!

Serving platters made of walnut!

Sublime in their appearance, unadorned in design, practical by compact formats and highly functional in combination - the solid wood boards of the series “Connect!” convince as a snack board, serving and cutting board or as a presentation platter, created by the combination of several elements. “Connect!” is an extremely versatile tool for everyday use. All information about “Connect!” are available on page 235.

"Solid"



card holder

walnut, varnished, slot 2 mm wide

item	l x w x h in cm	PU
4726	8x3x3	4 pcs



bowl "Solid"

walnut, oblique, food-safe sealed, not dishwasher-safe

item	Ø in cm	height in cm
4761	14	9



bread basket "Solid"

walnut, food-safe sealed, not dishwasher-safe, boat-shaped

item	l x w x h in cm
4770.24	24.5x12x5



cutlery/napkin box "Solid"

walnut, food-safe sealed, not dishwasher-safe, with rubber feet in the lid (soft closure, can be opened to an angle of 90° only) and at the bottom, with black felt insert, stainless steel platter with space for an engraving (price and quantity upon request), height with open lid: 15.5 cm

item	l x w x h in cm	size inside in cm
4766	28.8x11.8x6	26x8.7

The platter made of dark grey glass is available on page 168.



4591 + 4588



cutlery/napkin box

melamine, black, surface matt, food-safe, dishwasher-safe, with 4 rubber feet, not suitable for microwave and combi steam oven, for cocktail napkins folded to 1/8

item	l x w x h in cm	content in l	PU
4591	16x6x4.5	0.26	2 pcs



cutlery box

melamine, black, surface matt, food-safe, dishwasher-safe, not suitable for microwave and combi steam oven, for cutlery with a length of up to 23.5 cm

item	l x w x h in cm	content in l	PU
4594	26.5x16.2x7.2	2.25	4 pcs



cutlery box "Solid"

walnut, food-safe sealed, not dishwasher-safe, with acrylic glass lid, with 4 rubber feet, for cutlery with a length of up to 24.3 cm

item	l x w x h in cm
4720	26.5x16.2x8



buffet display "Solid"

walnut, food-safe sealed, not dishwasher-safe, bottom side open, can be used as a stand or as a container

item	l x w x h in cm	PU
4767.12	12x12x12	2 pcs
4767.24	12x12x24	2 pcs



4594 + 4589



The melamine tray item 4589 in 1/1 GN format is available on page 131.

Grooves to let the water from the dishwasher run off



The cutlery boxes item 4720 (wood) and 4594 (melamine) are stackable in all commercial transport boxes in format 60 cm x 40 cm



"Podia"



Hotel cosmetics: PAM Berlin Slipper & Hotel Supplies
www.pam-berlin.de

The buffet bridges and trays of the "Podia" series offer several advantages!

They are light but robust, flexibly usable and can be stored in a space-saving way. With its use as a display on the buffet, during coffee break or as a platter for fruit or little somethings in the hotel room - "Podia" offers multiple possibilities for use and flexible handling!

The tray in 1/2 GN format is especially suitable for different miniatures made of porcelain and glass. Slide-proof silicone coasters in different styles (page 214) guarantee a good grip during service.

All parts of this series consist of form-glued authentic wood veneer. The bridges are available in two types of wood. The light version harmonises very well with mundane but also with rustic-style furnishing, the version with the black-brown stripes appears exotic and modern.



1/2 GN tray "Podia"

genuine wood veneer, dark (black-brown striped), not dishwasher-safe

item	l x w in cm	GN	PU
8732.03	32.5 x 26.5	1/2	6 pcs



buffet bridge "Podia", triple pack

genuine wood veneer, not dishwasher-safe, set consists of size S (30x20x6cm), size M (36x20x9cm) and size L (42.5x20x12cm)

item	version	PU
8730	dark colouring (black-brown striped)	1 set



buffet bridge "Podia", triple pack

genuine wood veneer, not dishwasher-safe, set consists of size S (30x20x6cm), size M (36x20x9cm) and size L (42.5x20x12cm)

item	version	PU
8731	light colouring (similar to oak)	1 set

Please note:



Not dishwasher-safe!
Do not immerse in water!



More products from the room service/hotel room field are available as of page 275.