

# LUX



abert®

**abert**<sup>®</sup>

Combina i diversi elementi per personalizzare il tuo carrello.

Design lineare ed eleganza dal sapore naturale sono i tratti distintivi di questa linea: una proposta di carrelli da comporre a piacimento, mixando gli elementi standard per un servizio unico e su misura.

*Combine the different elements to customise your trolley.*

*Linear design and natural elegance are the distinguishing features of this line: a range of trolleys that you can compose as you wish, by mixing the standard elements for a bespoke and unique service.*



**Carrello Gueridon**

Gueridon trolley

	Cm	Colore / Color
 V42 04 51 001	90x50 h.80	Rovere chiaro / Light oak
 V42 04 51 002	90x50 h.80	Rovere scuro / Dark oak

**Carrello Servire con due cassetti**

Service trolley, 2-drawer

	Cm	Colore / Color
 V42 04 51 003	90x50 h.80	Rovere chiaro / Light oak
 V42 04 51 004	90x50 h.80	Rovere scuro / Dark oak



**Top dolci / formaggi refrigerato**

Dessert/cheese top, refrigerated

	Cm	Colore / Color
 V42 04 51 T05	90x50 h.28	Rovere chiaro / Light oak
 V42 04 51 T06	90x50 h.28	Rovere scuro / Dark oak



**Carrello Gueridon**

Gueridon trolley

	Cm	Colore / Color
 V42 04 51 001	90x50 h.80	Rovere chiaro / Light oak
 V42 04 51 002	90x50 h.80	Rovere scuro / Dark oak

**Top bar con ringhiera 90x50**

Bar top with railing

	Cm	Colore / Color
 V42 04 51 T03	90x50 h.10,5	Rovere chiaro / Light oak
 V42 04 51 T04	90x50 h.10,5	Rovere scuro / Dark oak

**Carrello Servire con due cassetti**

Service trolley, 2-drawer

	Cm	Colore / Color
 V42 04 51 003	90x50 h.80	Rovere chiaro / Light oak
 V42 04 51 004	90x50 h.80	Rovere scuro / Dark oak



**Carrello bar / liquori**

Bar/liquor trolley

	Cm	Colore / Color
 V42 04 51 015	90x50 h.90,5	Rovere chiaro / Light oak
 V42 04 51 016	90x50 h.90,5	Rovere scuro / Dark oak

**Carrello dolci / formaggi refrigerato**

Dessert/cheese trolley, refrigerated

	Cm	Colore / Color
 V42 04 51 013	90x50 h.108	Rovere chiaro / Light oak
 V42 04 51 014	90x50 h.108	Rovere scuro / Dark oak



**Accessori per foro**

Hole accessories

**Contenitore in acciaio per GN**

Steel container for GN

V42 05 51 006 43x40 h. 16 Cm

**Compatibile con**

Compatible with

**1 x GN 2/3**V01 05 72 G23D h. 15 Cm  
V01 05 15 G23 coperchio / lid**1 x GN 1/3**V01 05 72 G13D h. 15 Cm  
V01 05 15 G13 coperchio / lid**Scaldavivande GN 2/3**

GN 2/3 chafing dish

305 05 52 695 Coperchio in acciaio / St. Steel lid  
305 05 52 694 Coperchio in vetro / Glass lid**Piastra induzione + piano lavoro acciaio**

Induction plate + steel countertop

V42 05 51 002 84x40,5 h.7 Cm

**Accessori ad incastro sulle ringhiere**

Interlocking accessories on railings

**Porta bottiglie / glacette**

Bottle/bottle-cooler holder

V420551003 46x17 h.1,6 Cm

**Compatibile con**

Compatible with

**3 x Glacette**

Bottle coolers

V78 05 24 01 01 401 Ø12 h.17 Cm

**Porta sorbetti**

Sherbet-pot holder

V42 05 51 004 46x17 h.1,6 Cm

**Compatibile con**

Compatible with

**2 x Sorbetti**

Ice bucket

V78 05 20 00 11 401 Ø15 h.19,5 Cm

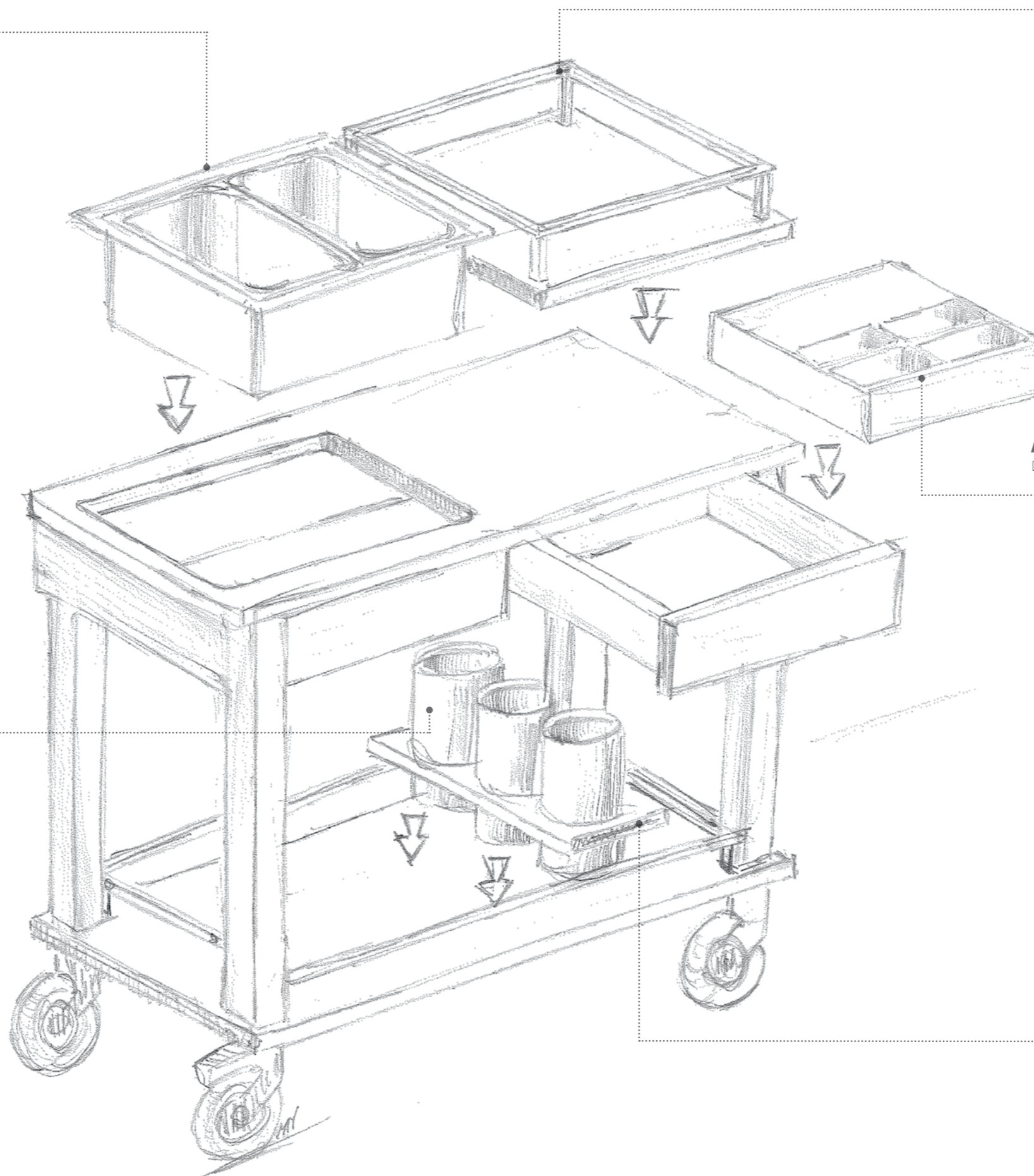
**Top bar con ringhiera 41x50**

Bar top with railing 41x50

V42 04 51 T01 41x50 h.10,5 Cm

V42 04 51 T02 41x50 h.10,5 Cm

**Tagliere in legno**

Wood cutting board

V42 04 71 001 38x40 h.2 Cm

**Accessori per cassetto**

Drawer accessories

**Inserto portaposate**

Cutlery-holder insert

V42 04 94 001 36x29 h.7 Cm

**Inserto portacondimenti**

Condiment-holder insert

V42 05 51 005 36x29 h.7 Cm

**Compenso poggia piatti**

Dish tray

V42 04 42 001 29,5x25 h. 7 Cm

**Ringhiera porta accessori**

Accessory-holder railing

V42 05 51 001 46x86 h.8 Cm



**Carrello cocktail**

Cocktail trolley

	Cm	Colore / Color
 V42 04 51 011	90x50 h.90,5	Rovere chiaro / Light oak
 V42 04 51 012	90x50 h.90,5	Rovere scuro / Dark oak

**Carrello arrosti**

Roast-beef trolley

	Cm	Colore / Color
 V42 04 51 009	90x50 h.90	Rovere chiaro / Light oak
 V42 04 51 010	90x50 h.90	Rovere scuro / Dark oak





**Carrello Flambé ad induzione**

Flambé trolley - induction

	Cm	Colore / Color
 V42 04 51 007	90x50 h.80	Rovere chiaro / Light oak
 V42 04 51 008	90x50 h.80	Rovere scuro / Dark oak

**Carrello multiuso**

Universal trolley

	Cm	Colore / Color
 V42 04 51 005	90x50 h.80	Rovere chiaro / Light oak
 V42 04 51 006	90x50 h.80	Rovere scuro / Dark oak





**Top bar con ringhiera 90x50**

Bar top with railing 41X50

	Cm	Colore / Color
V42 04 51 T03	90x50 h.10,5	Rovere chiaro / Light oak
V42 04 51 T04	90x50 h.10,5	Rovere scuro / Dark oak

**Top dolci / formaggi refrigerato**

Dessert/cheese top, refrigerated

	Cm	Colore / Color
V42 04 51 T05	90x50 h.28	Rovere chiaro / Light oak
V42 04 51 T06	90x50 h.28	Rovere scuro / Dark oak

**Ringhiera porta accessori**

Accessory-holder railing

**Inox 18/10 - St. Steel**

V42 05 51 001	Cm 46x86 h.8
---------------	-----------------

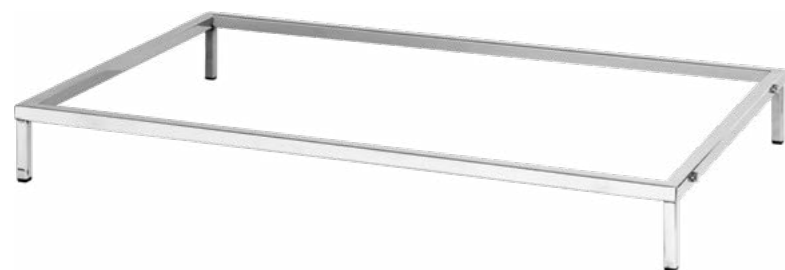
**Piastra induzione + piano lavoro acciaio**

Induction plate + steel countertop

V42 05 51 002	Cm 84x40,5 h.7
---------------	-------------------

**Vasca ghiaccio / secchio champagne**

Ice pan / champagne bucket

**Inox 18/10 - St. Steel**

<b>Contenitore in acciaio per GN</b>	V42 05 51 006	43x40 h. 16
--------------------------------------	---------------	-------------

Steel container for GN

**Compatibile con**

Compatible with

<b>1 x GN 2/3</b>	V01 05 72 G23D V01 05 15 G23	h. 15 Cm coperchio / lid
<b>1 x GN 1/3</b>	V01 05 72 G13D V01 05 15 G13	h. 15 Cm coperchio / lid

**Top bar con ringhiera 41x50**

Bar top with railing 41X50

	Cm	Colore / Color
V42 04 51 T01	41x50 h.10,5	Rovere chiaro / Light oak
V42 04 51 T02	41x50 h.10,5	Rovere scuro / Dark oak



**Scaldavivande GN 2/3**

GN 2/3 chafing dish

	Cm	H cm	
305 05 52 695	43 x 40	21	Con coperchio in acciaio / St. Steel lid
305 05 52 694	43 x 40	21	Con coperchio in vetro / Glass lid

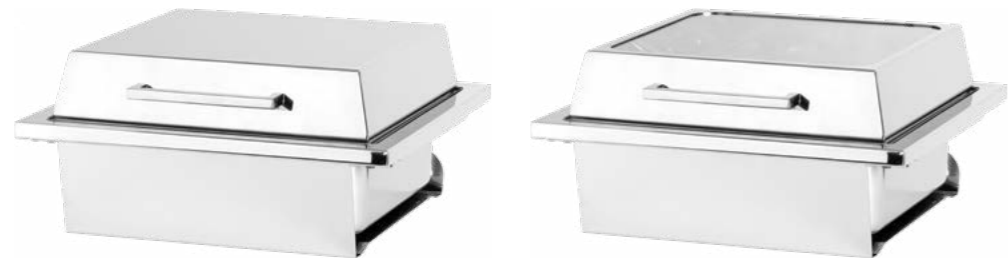
**Fornelletto per scaldavivande**

Chafing-dish burner

V77 05 52 FDC	Fornelletto / Burner (incluso / included)
B25 05 52 675	Supporto / Support (incluso / included)

**Piastra elettrica per scaldavivande**

Heating element for chafing-dishes

non incluso / not included

	V	W	Hz
V77 05 52 PCT	220	500	50
V77 05 52 PCT1	230	250	

Con regolatore / With power regulator

**Tagliere in legno**

Wood cutting board

	Cm
V42 04 71 001	38x40 h.2

**Porta bottiglie / glacette**

Bottle/bottle-cooler holder

**Inox 18/10 - St. Steel**

	Cm
V42 05 51 003	46x17 h.1,6

**Compatibile con**

Compatible with

**3 x Glacette**  
Bottle coolers

V78 05 24 01 01 401

Ø12 h.17 Cm

**Porta sorbettiere**

Sherbet-pot holder

**Inox 18/10 - St. Steel**

	Cm
V42 05 51 004	46x17 h.1,6

**Compatibile con**

Compatible with

**2 x Sorbettiere**  
Ice bucket

V78 05 20 00 11 401

Ø15 h.19,5 Cm



**Inserto portaposate**

Cutlery-holder insert

**Legno multistrato - Multilayer wood**V42 04 94 001      Cm  
36x29 h.7**Inserto portacondimenti**

Condiment-holder insert

**Inox 18/10 / 18/10 st. steel - ABS**V42 05 51 005      Cm  
36x29 h.7**Compenso poggia piatti**

Dish tray

**Legno multistrato - Multilayer wood**V42 04 42 001      Cm  
29,5x25 h. 7**Cassetto estraibile con chiusura ammortizzata**

Pull-out drawer with silent closing

**Gamba in legno massello e piani rivestiti in laminato**

Solid wood stand and tops, covered in laminate

**Ruota pivotante antistatica con freno ø13Cm**

Anti static pivoting wheel with brake, ø13Cm



**Carrello Basic**

Basic trolley

	Cm	Colore / Color
■ V43 04 51 002	80x50 h.80	Rovere scuro / Dark oak

**Caratteristiche tecniche:**

- Gamba in acciaio inox 18/10
- Ruota pivotante ø13 Cm
- Piani rivestiti in laminato
- Ruote pivotanti, di cui due con freno

**Technical characteristics:**

- *Stainless steel stand*
- *Pivoting wheel, ø13 Cm*
- *Laminate covered tops*
- *Pivoting wheels, two with brakes*

**Carrello Basic**

Basic trolley

	Cm	Colore / Color
■ V43 04 51 001	80x50 h.80	Rovere chiaro / Light oak

**Top Bar**

Bar top

	Cm	Colore / Color
■ V43 04 51 T01	80x50 h. 7,3	Rovere chiaro / Light oak
■ V43 04 51 T02	80x50 h. 7,3	Rovere scuro / Dark oak



# abert®

**ABERT S.p.A.**

Via Don P. Mazzolari, 17  
25050 Passirano (Bs) Italy

T. 0306853611

F. 0306577194

[info@abert.it](mailto:info@abert.it)

[www.abert.it](http://www.abert.it)

